

Ü SESİ GÖRSEL DİKTE

Verilen görsellerin isimlerini yazalım.

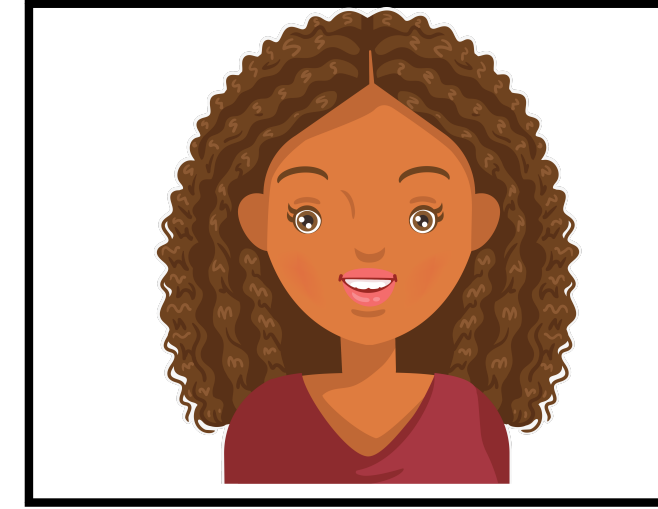

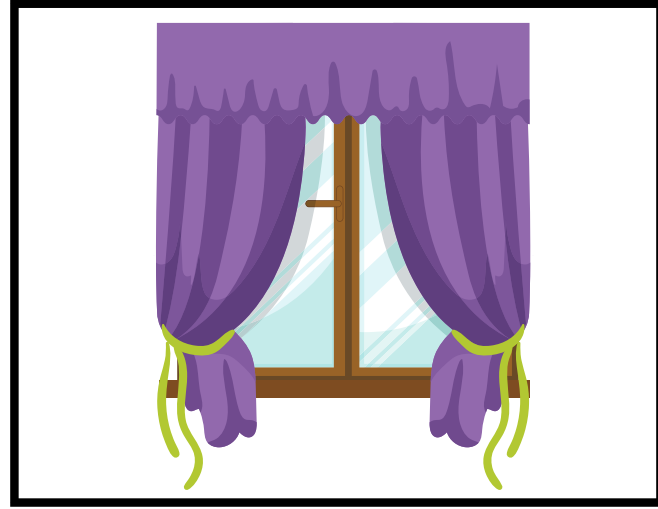

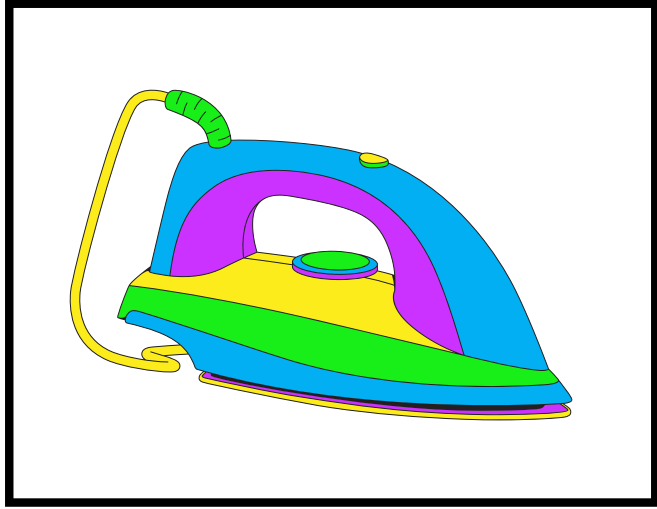
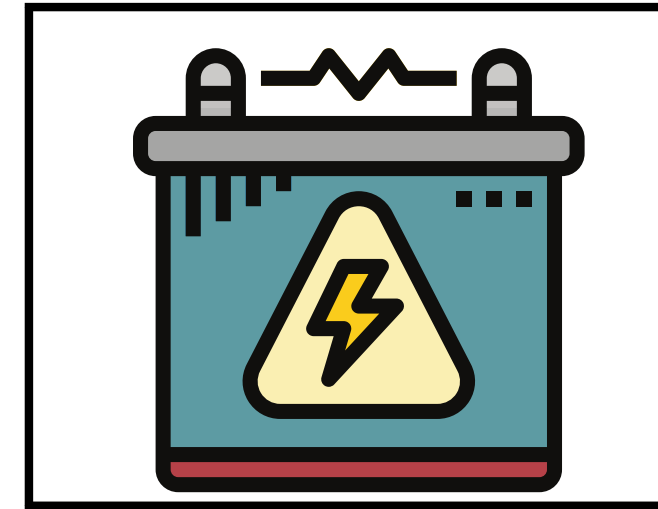
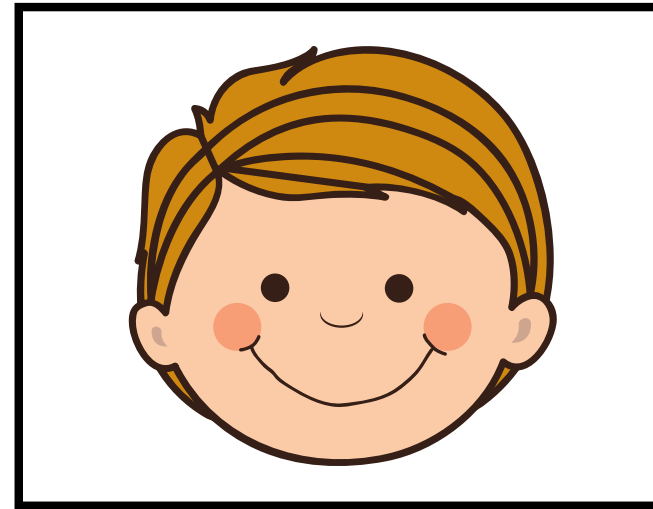
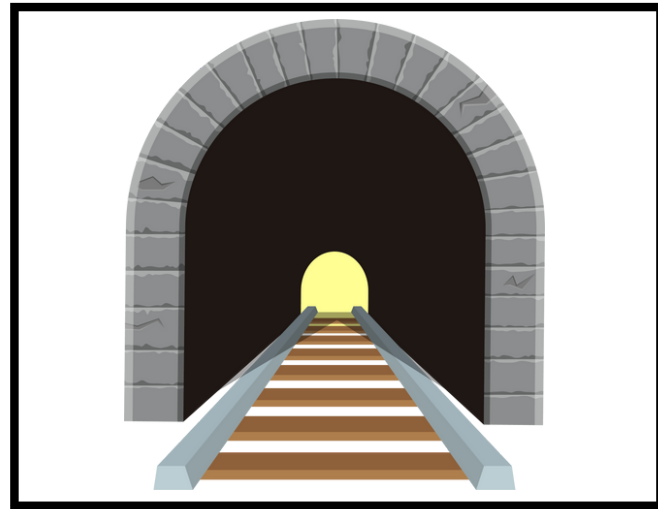
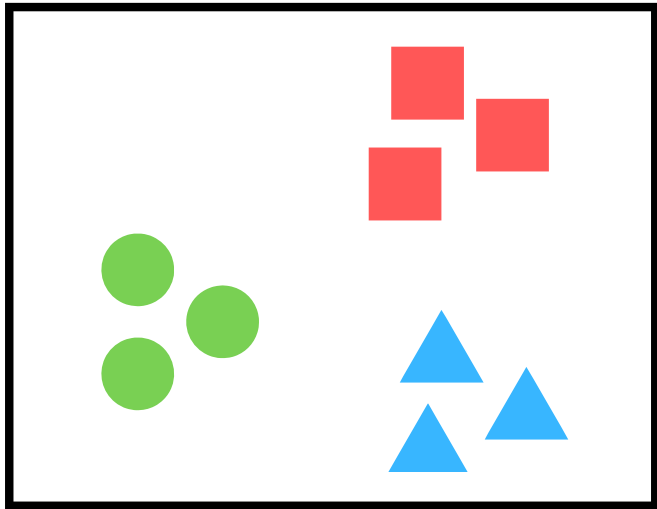
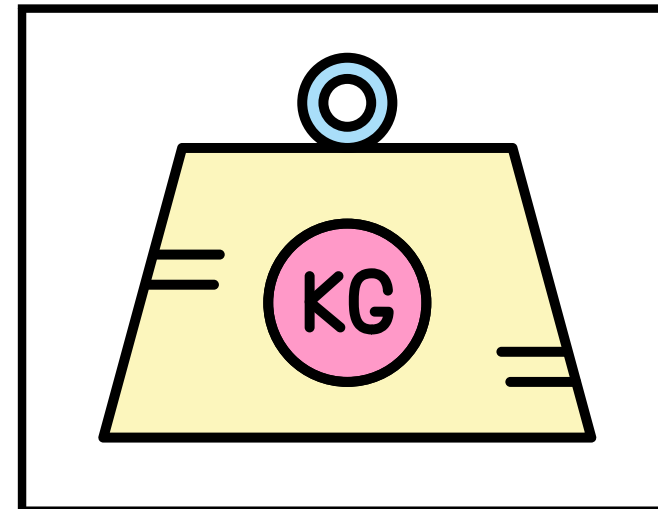
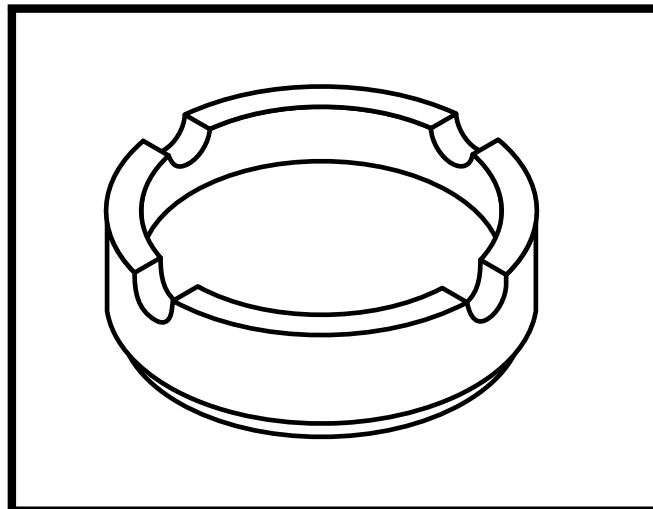
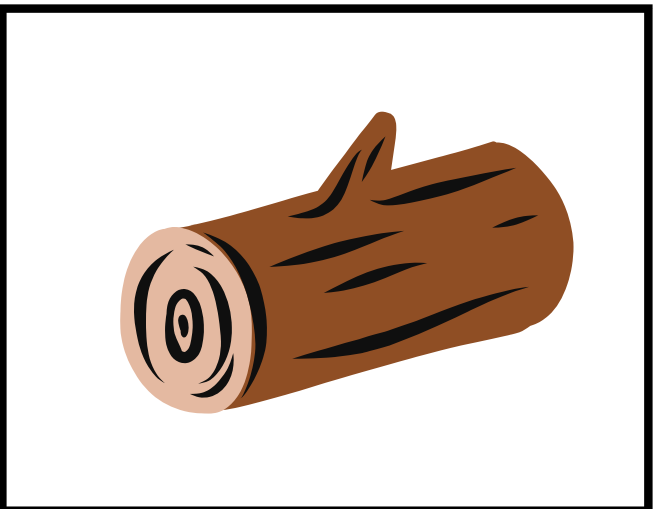



Ü SESİ GÖRSEL DİKTE

Verilen görsellerin isimlerini yazalım.

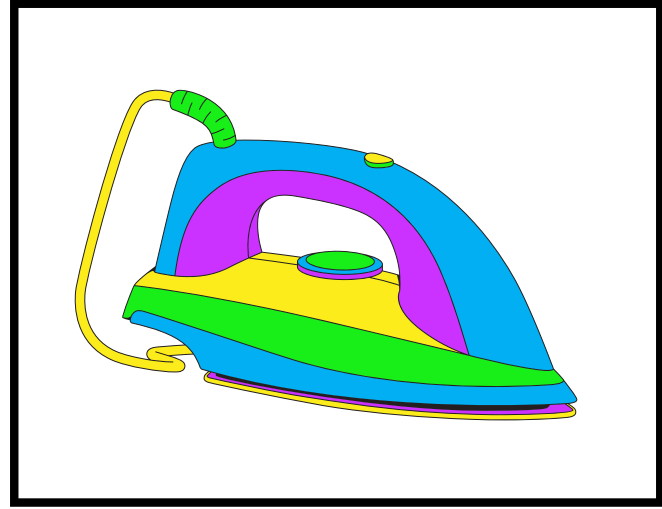

ütü



tül



ünlü



ünlem

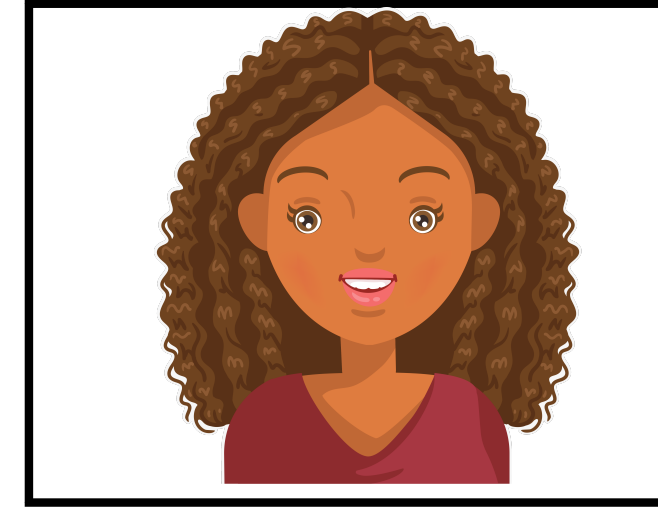

lüle



ülke

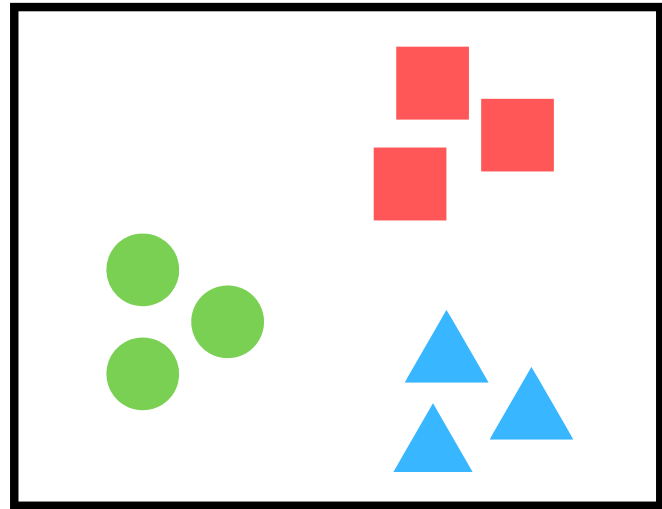

küme

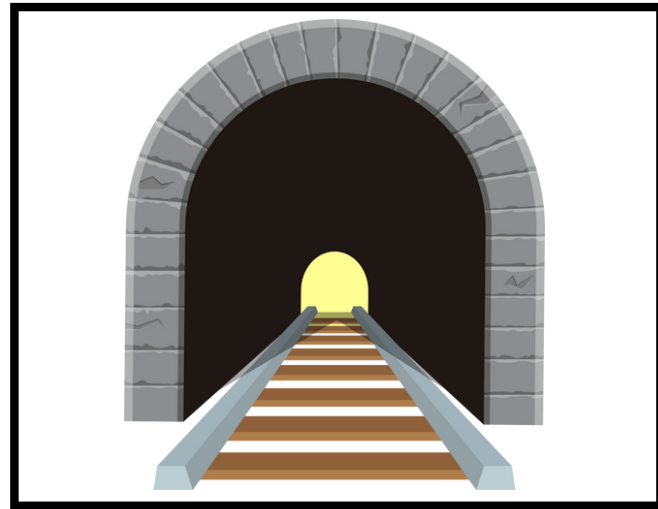

tünel



menü

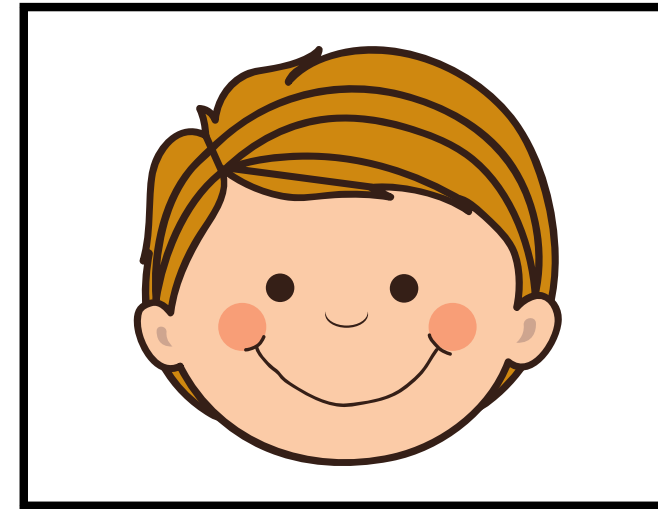

Ümit-Ünal

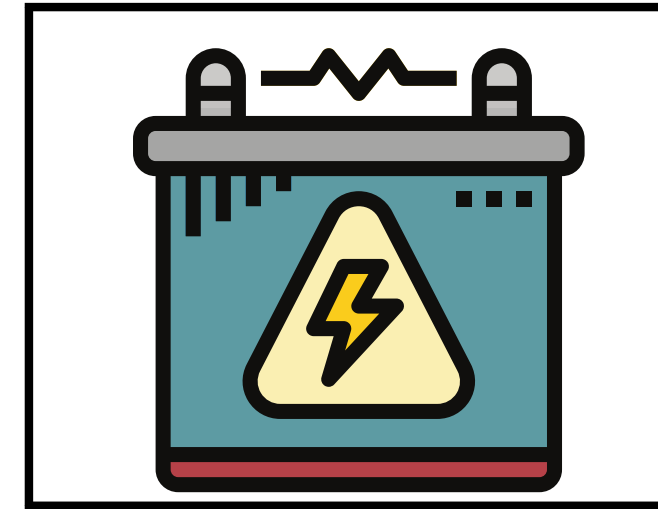

akü



kakül

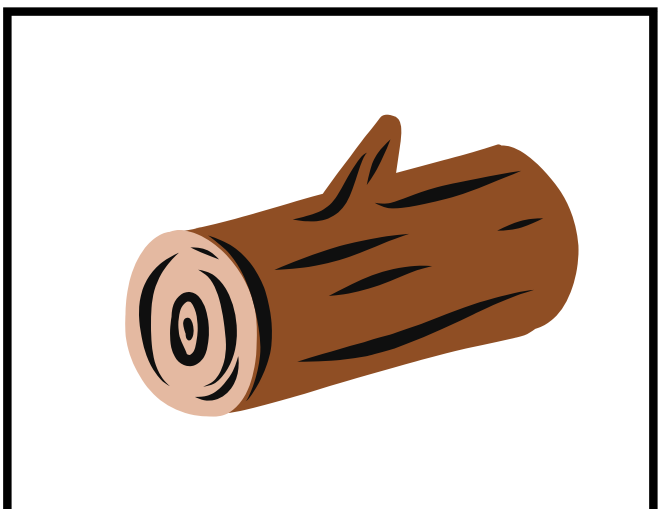

kütük



mülk



Ükü

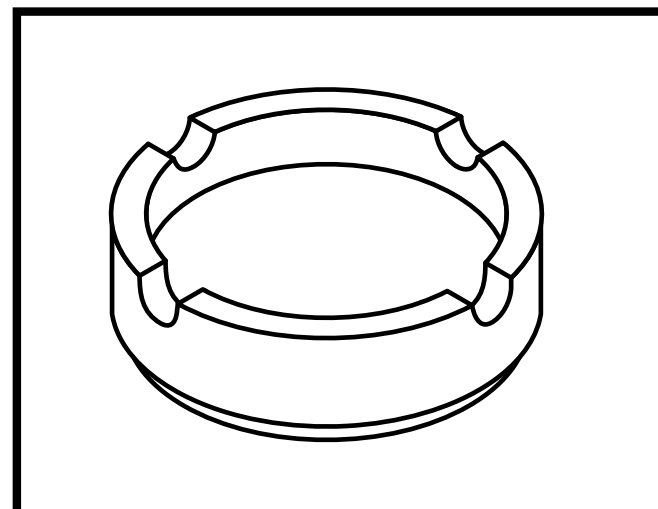

küllük

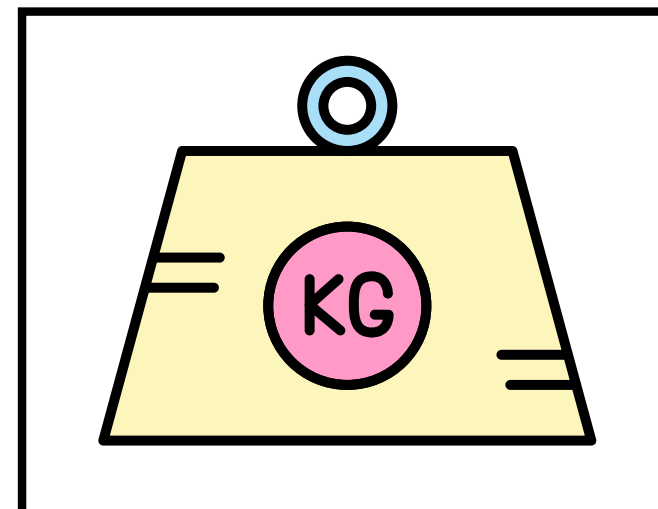

kütle



mülakat

