

Çizgilerin üzerinden dikkatlice çizelim.

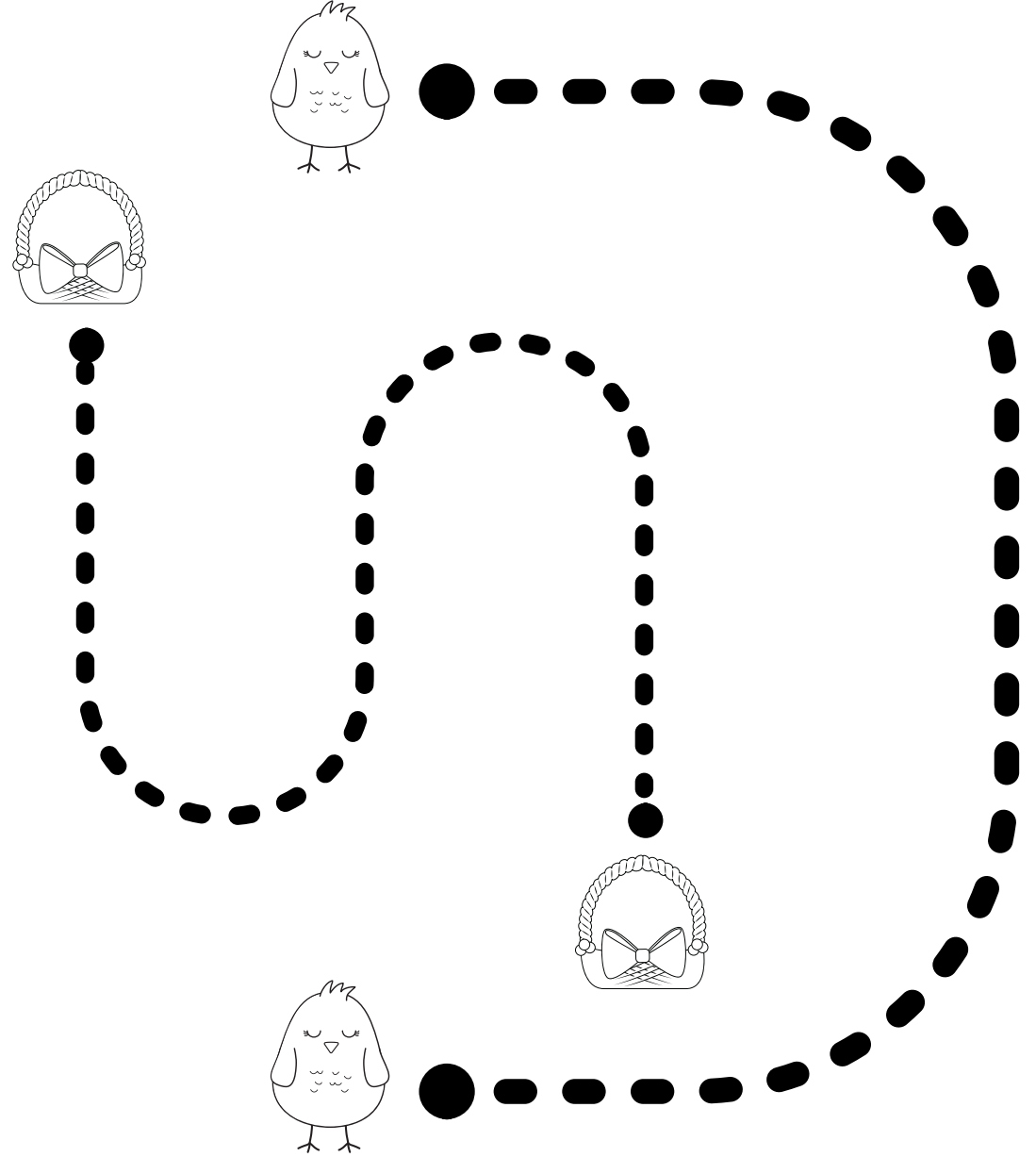

Başlangıç noktasından başlayarak çizgilerin üzerinden geçelim.

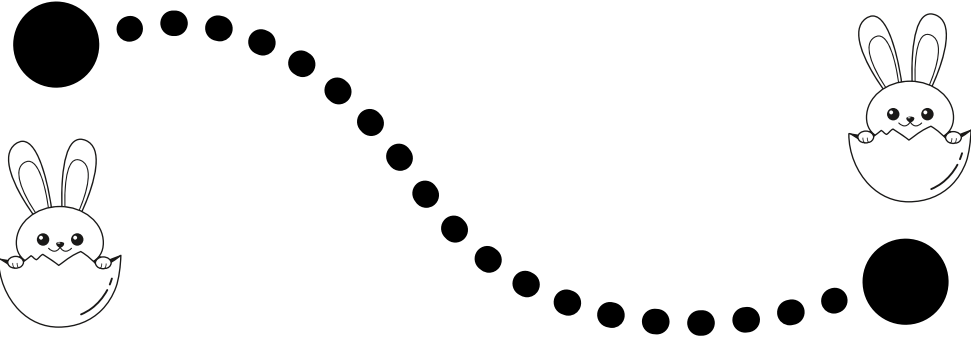
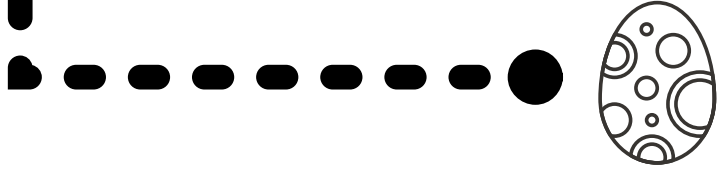
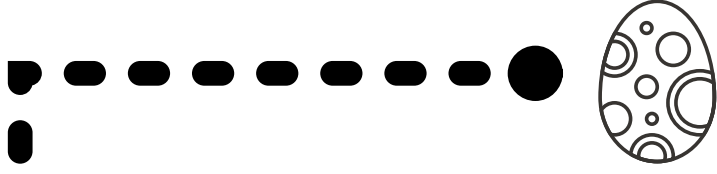
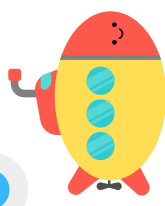
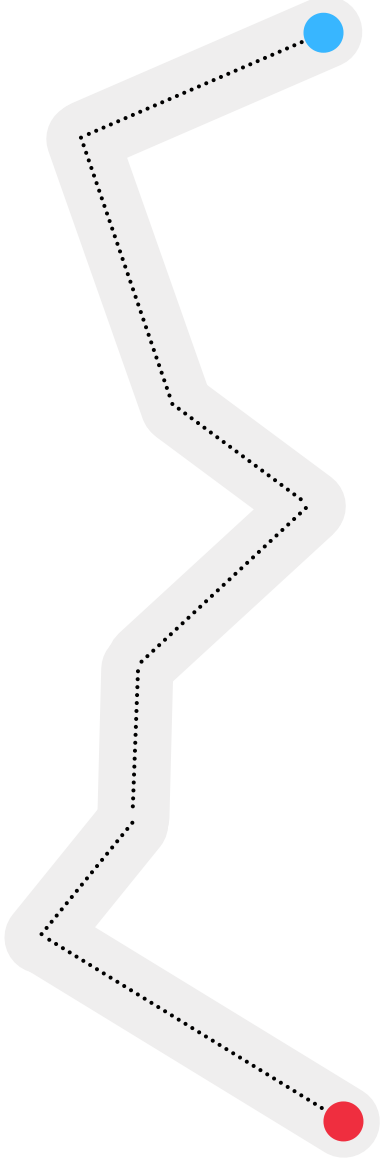
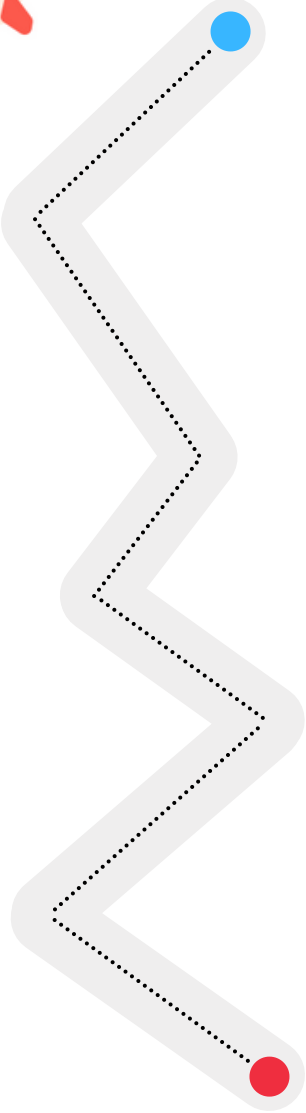
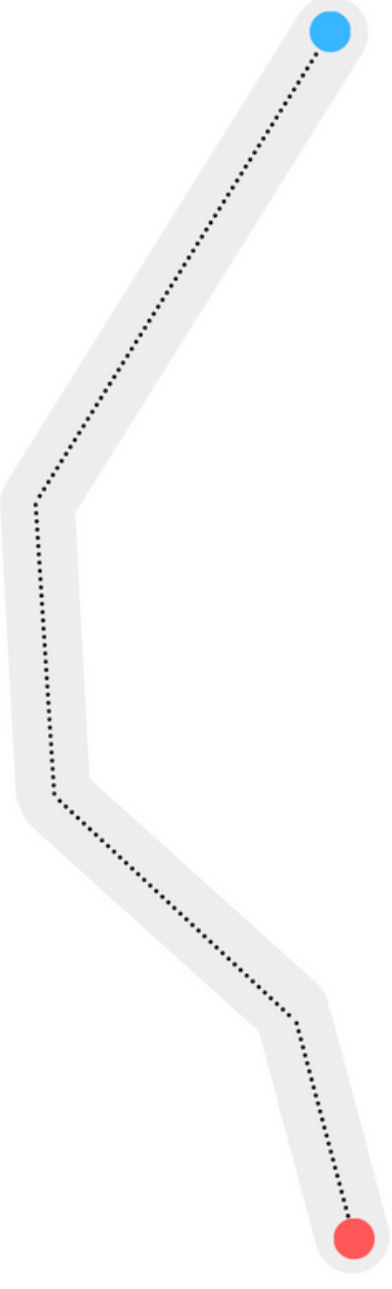
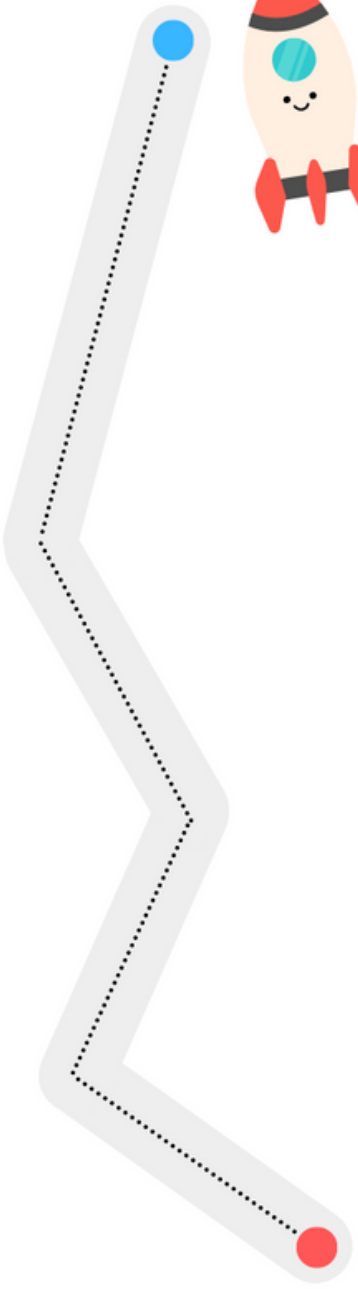

Başlangıç noktasından başlayarak çizgilerin üzerinden geçelim ve araçları varış noktasına ulaştıralım.

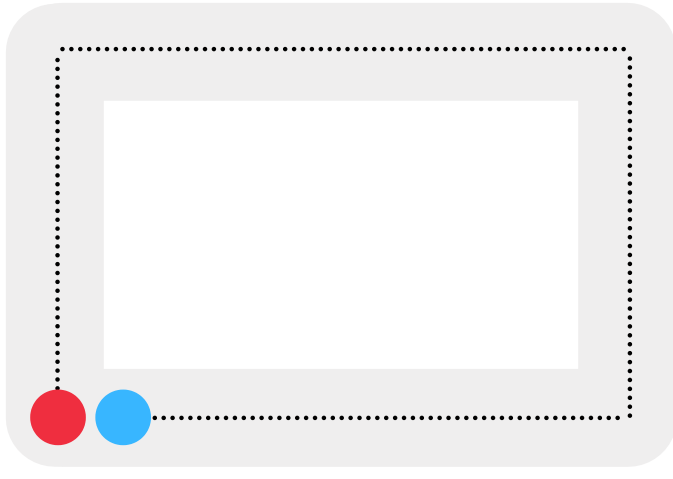
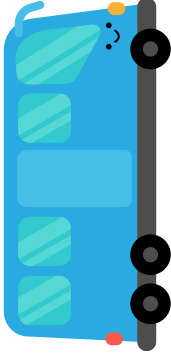
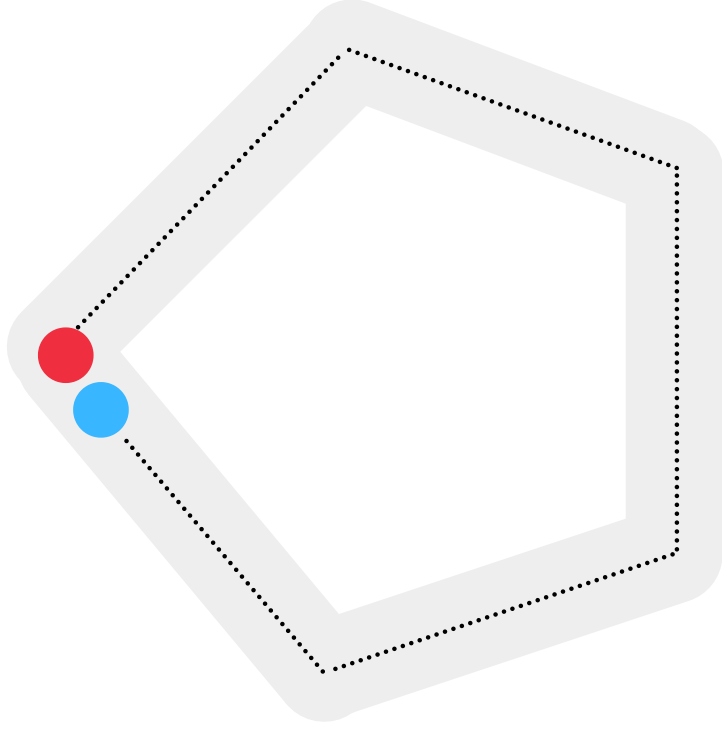
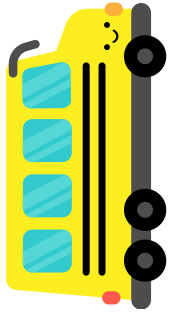
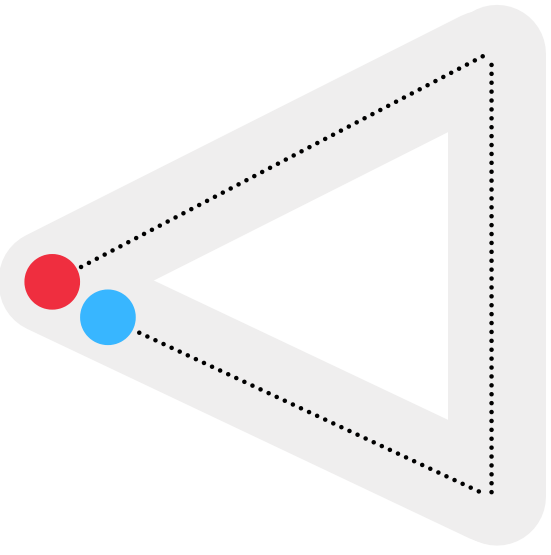
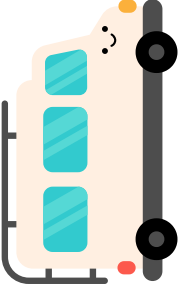
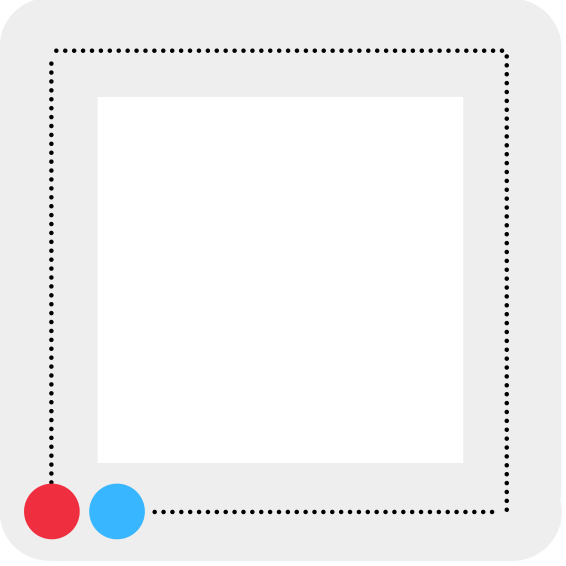

Dinozorun yumurtayı ulaşmasına yardım eder misin?

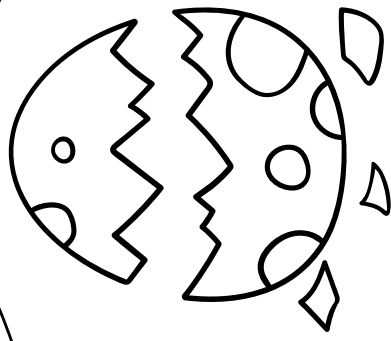
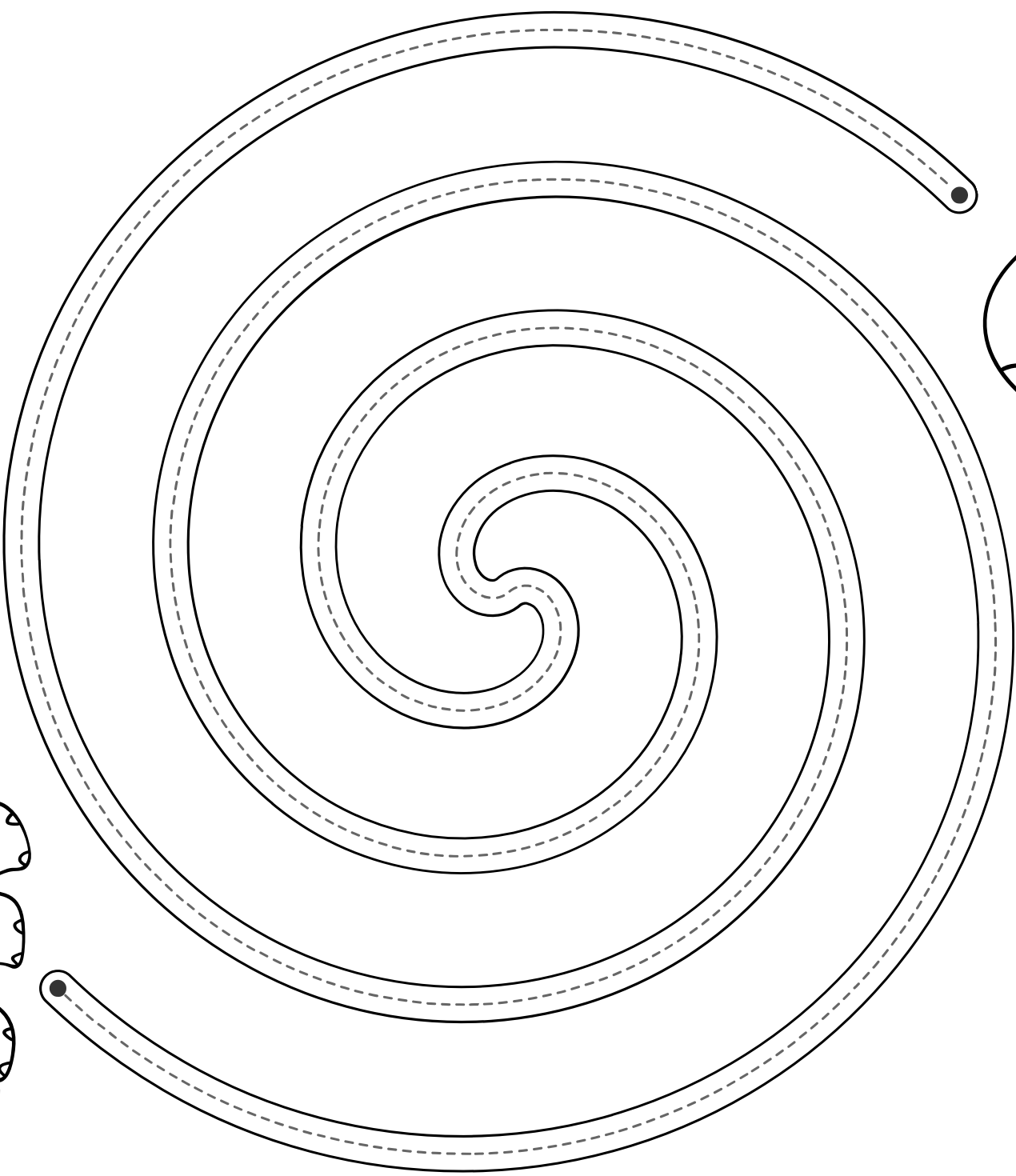
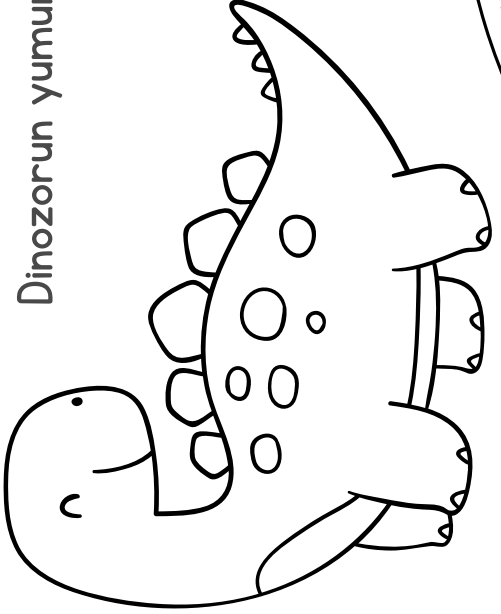

Dinozorun yumurta'yı ulaşmasına yardım eder misin?

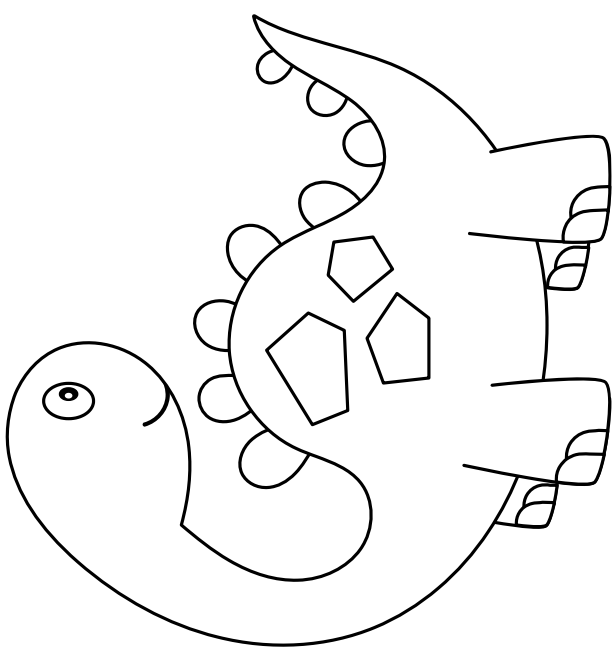
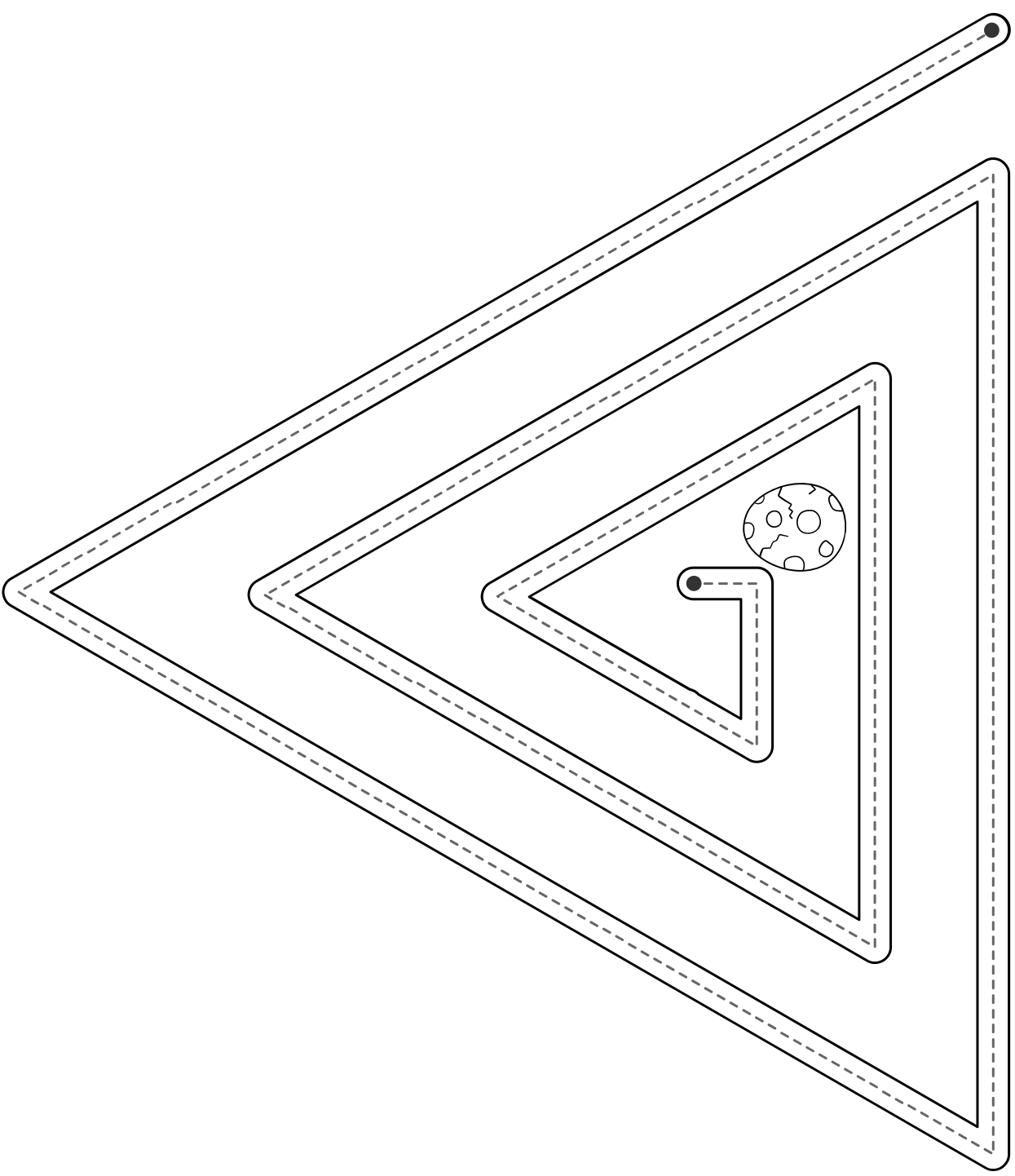

Dikkatli bir şekilde labirentteki çizgilerin üzerinden çizelim.

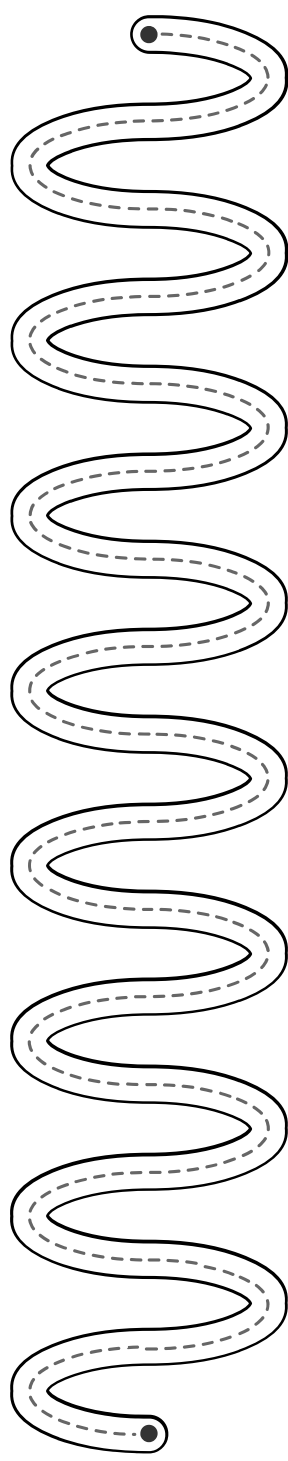
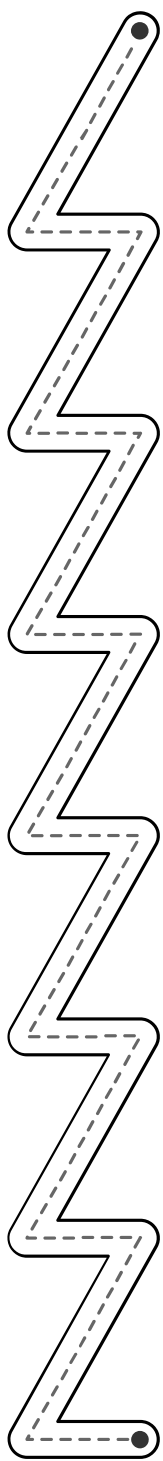
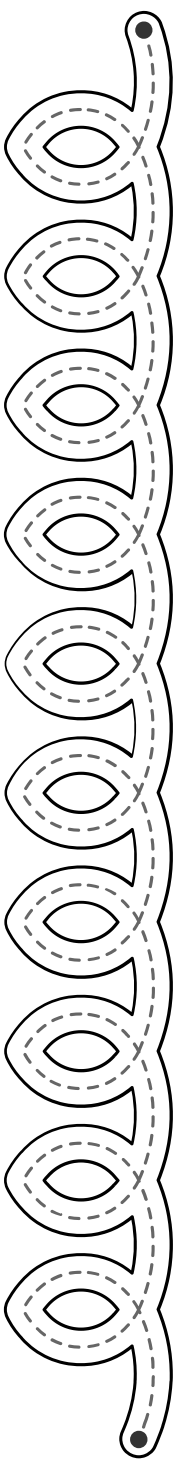
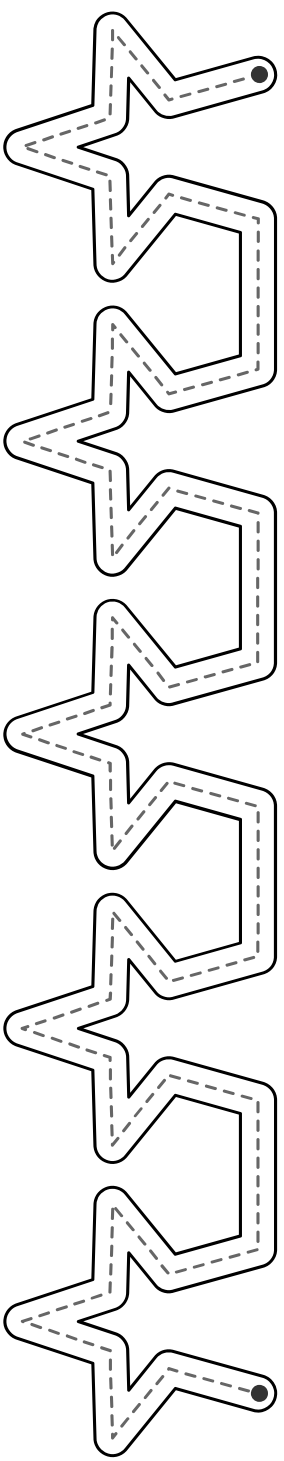
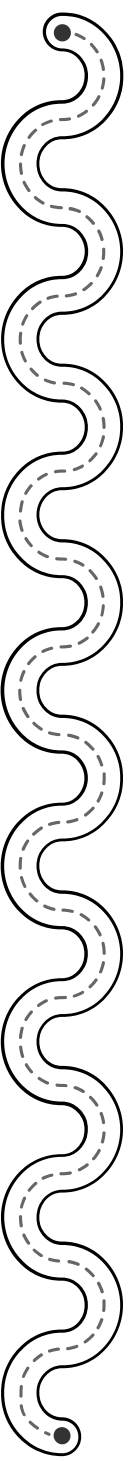

Dikkatli bir şekilde labirentteki çizgilerin üzerinden çizelim.

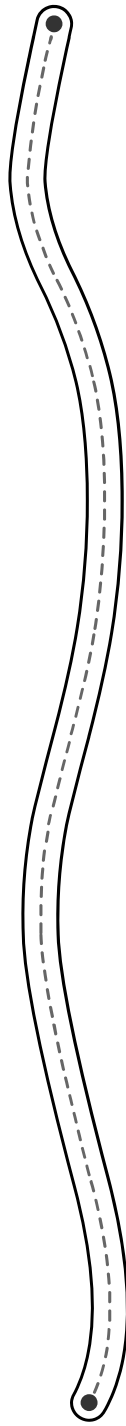
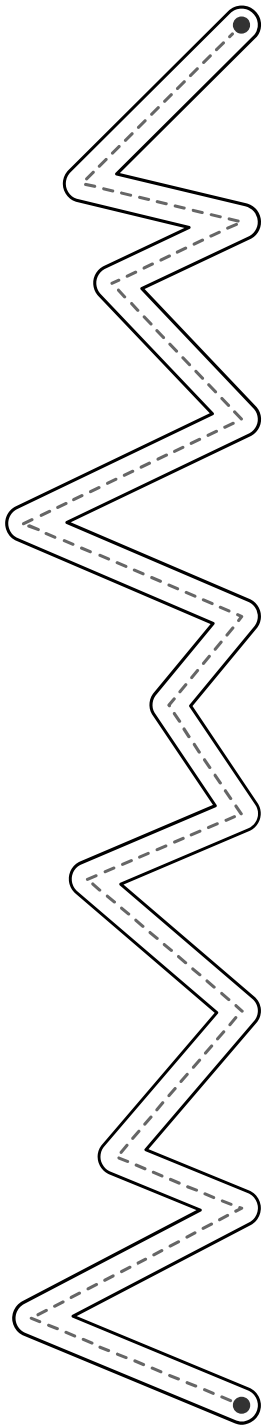
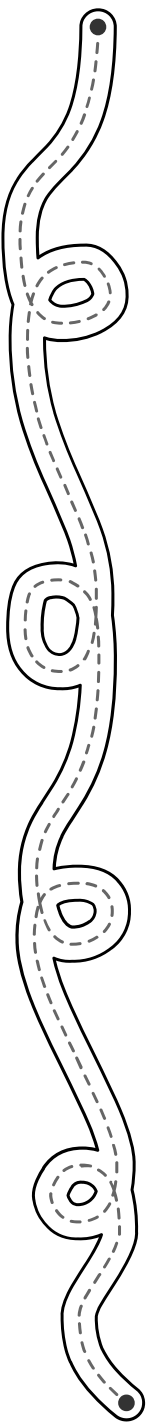
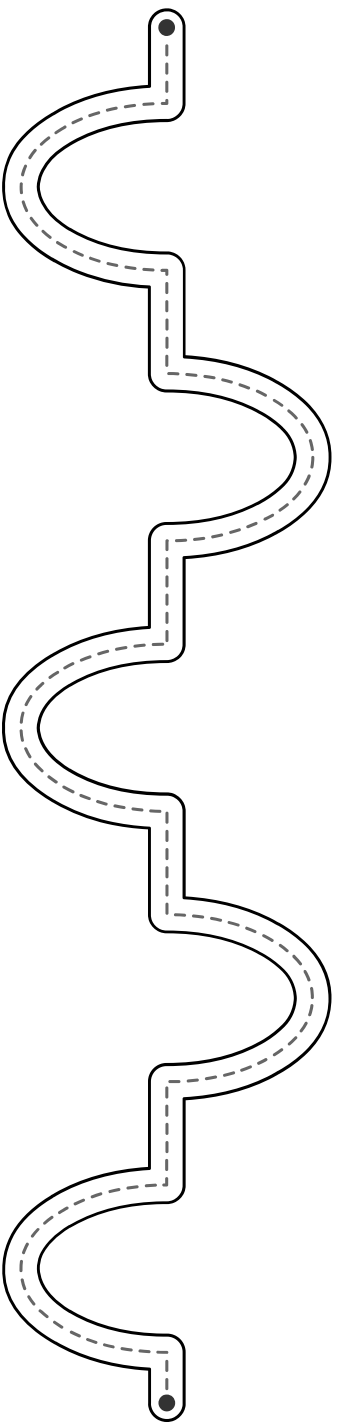
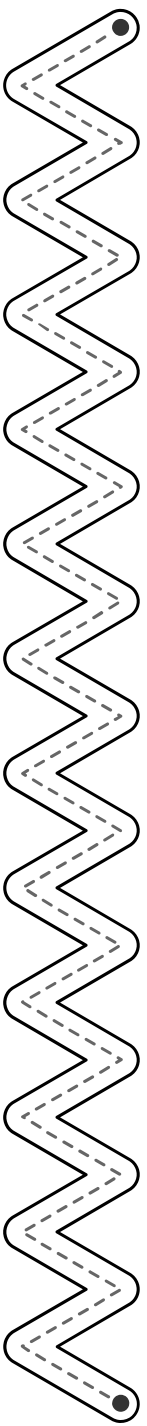
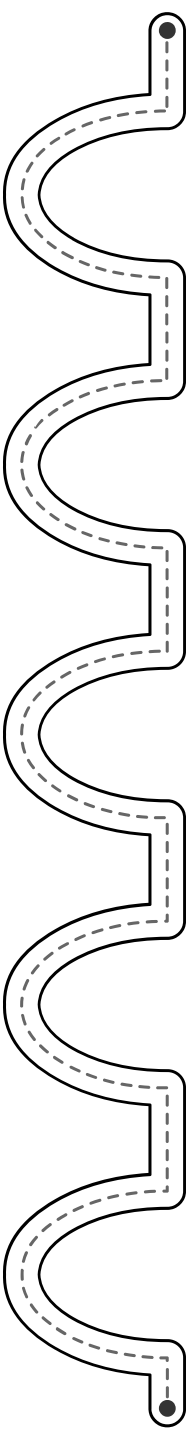

Çocukların okullarına gitmesine yardım edelim.

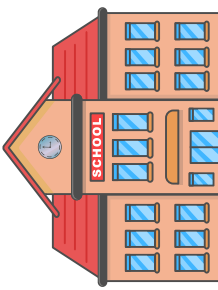
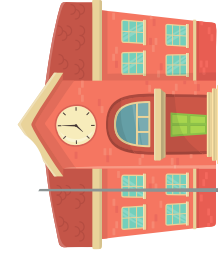
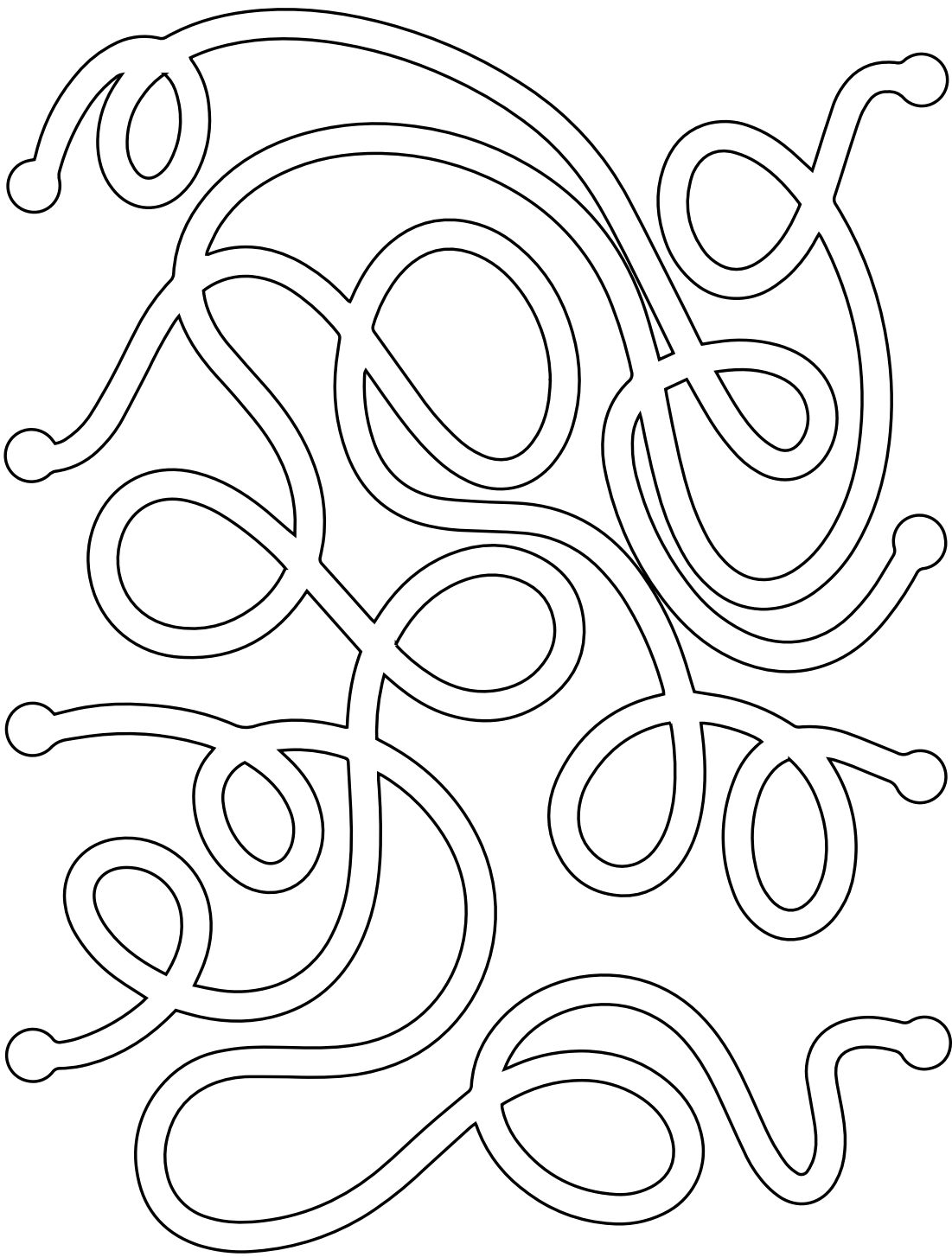
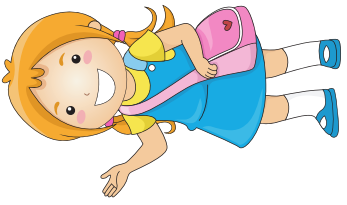
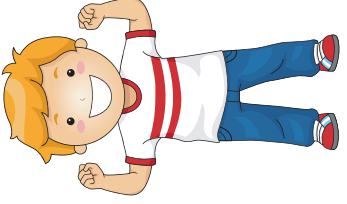
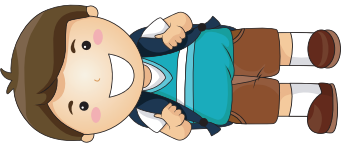

Acil durum görevlisinin aracını bulmasına yardım edelim.

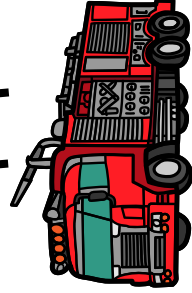
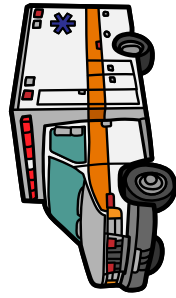
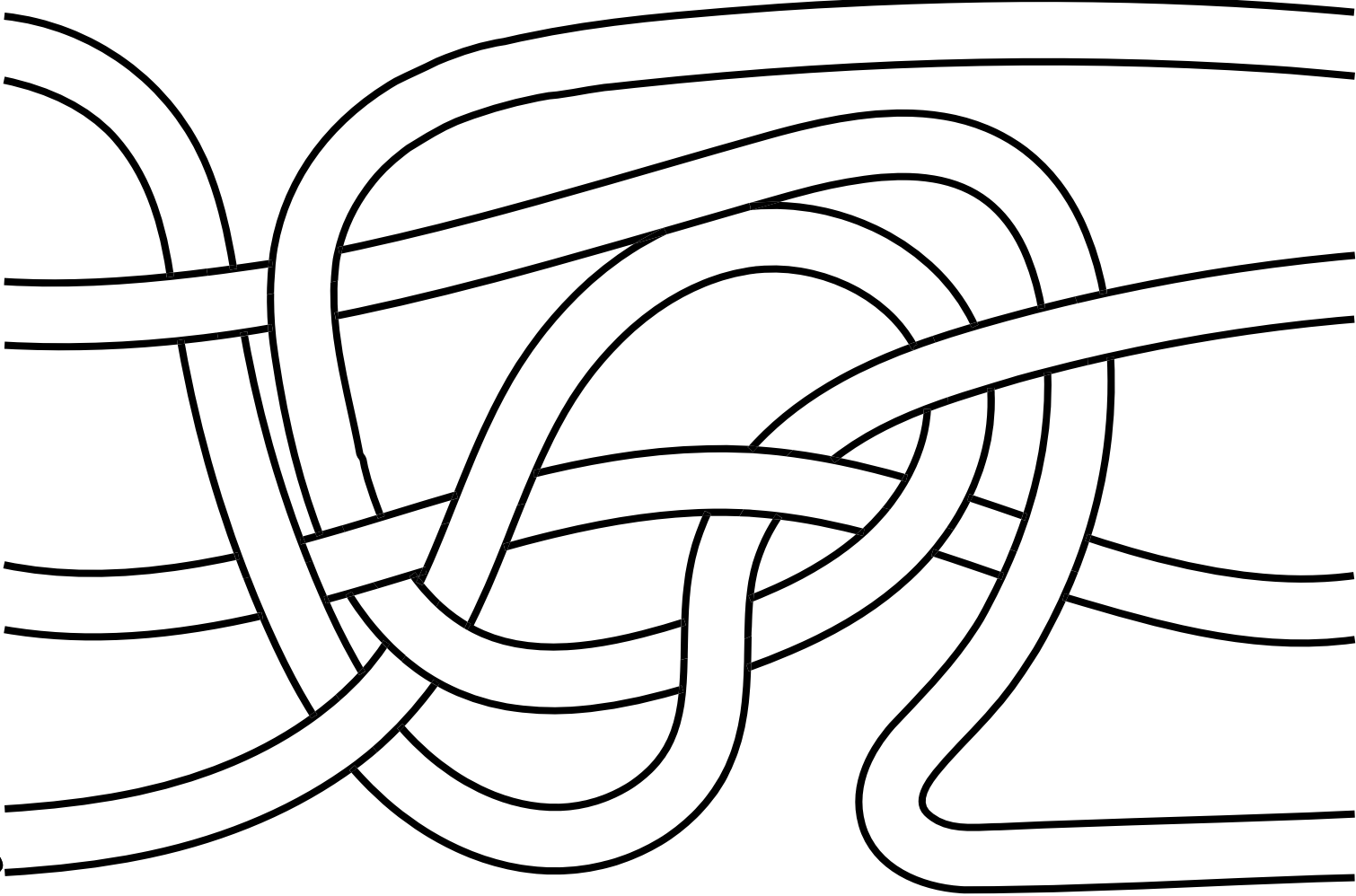
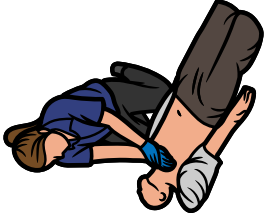
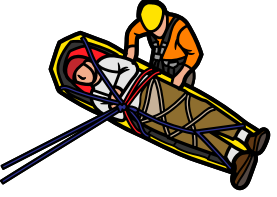

Dikkatli bir şekilde labirentteki çizgilerin üzerinden çizelim.

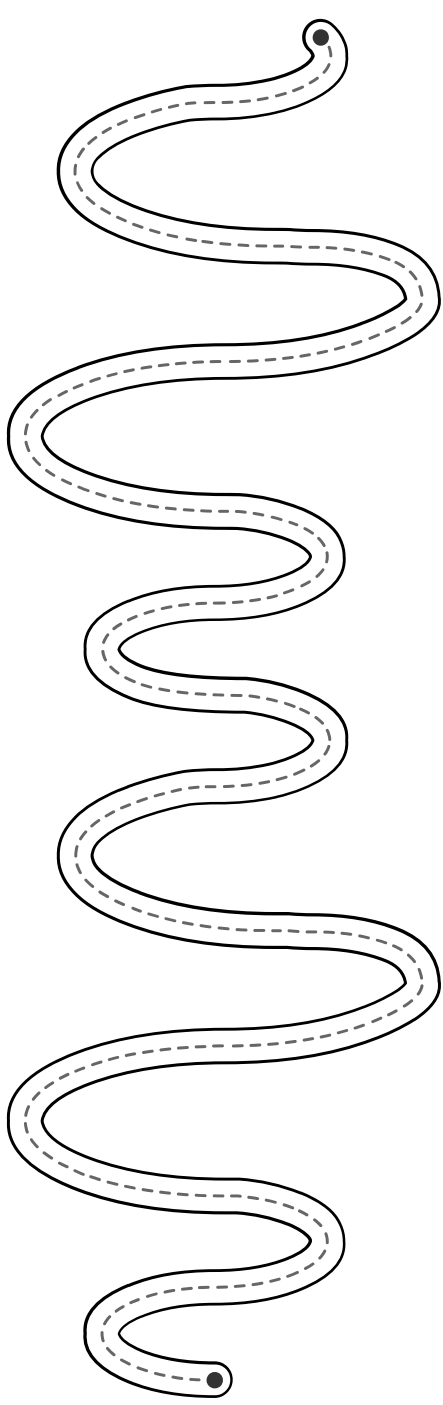
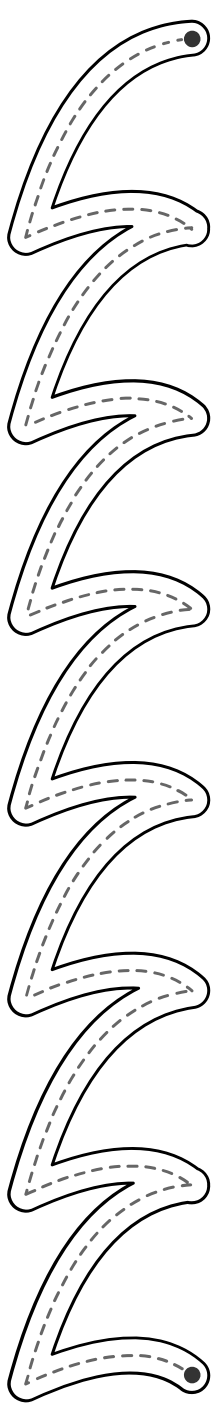
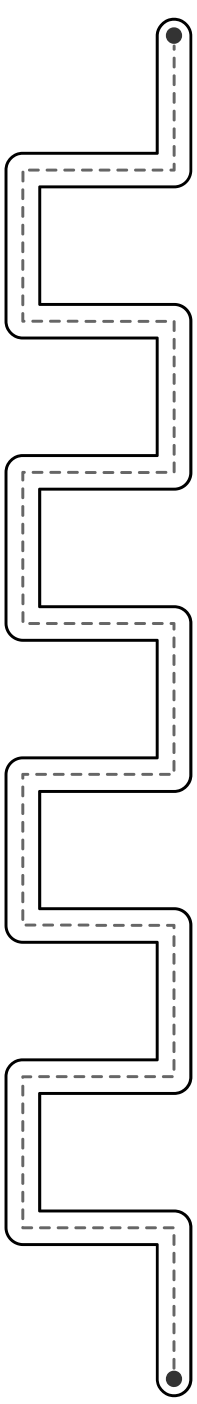
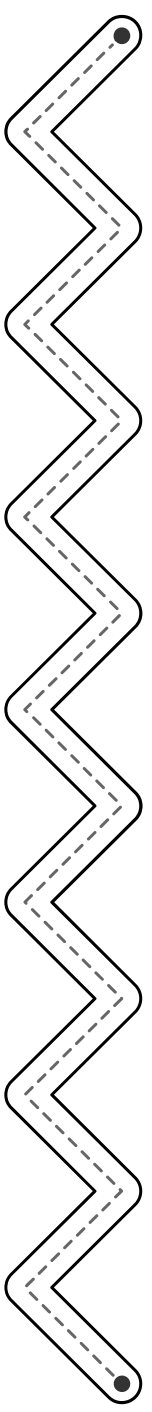
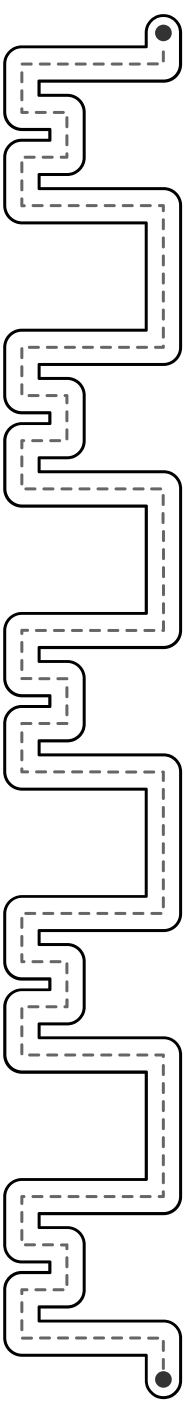

Arabayı işyerine ulaştıracak güvenli yolu bulalım.



Ev

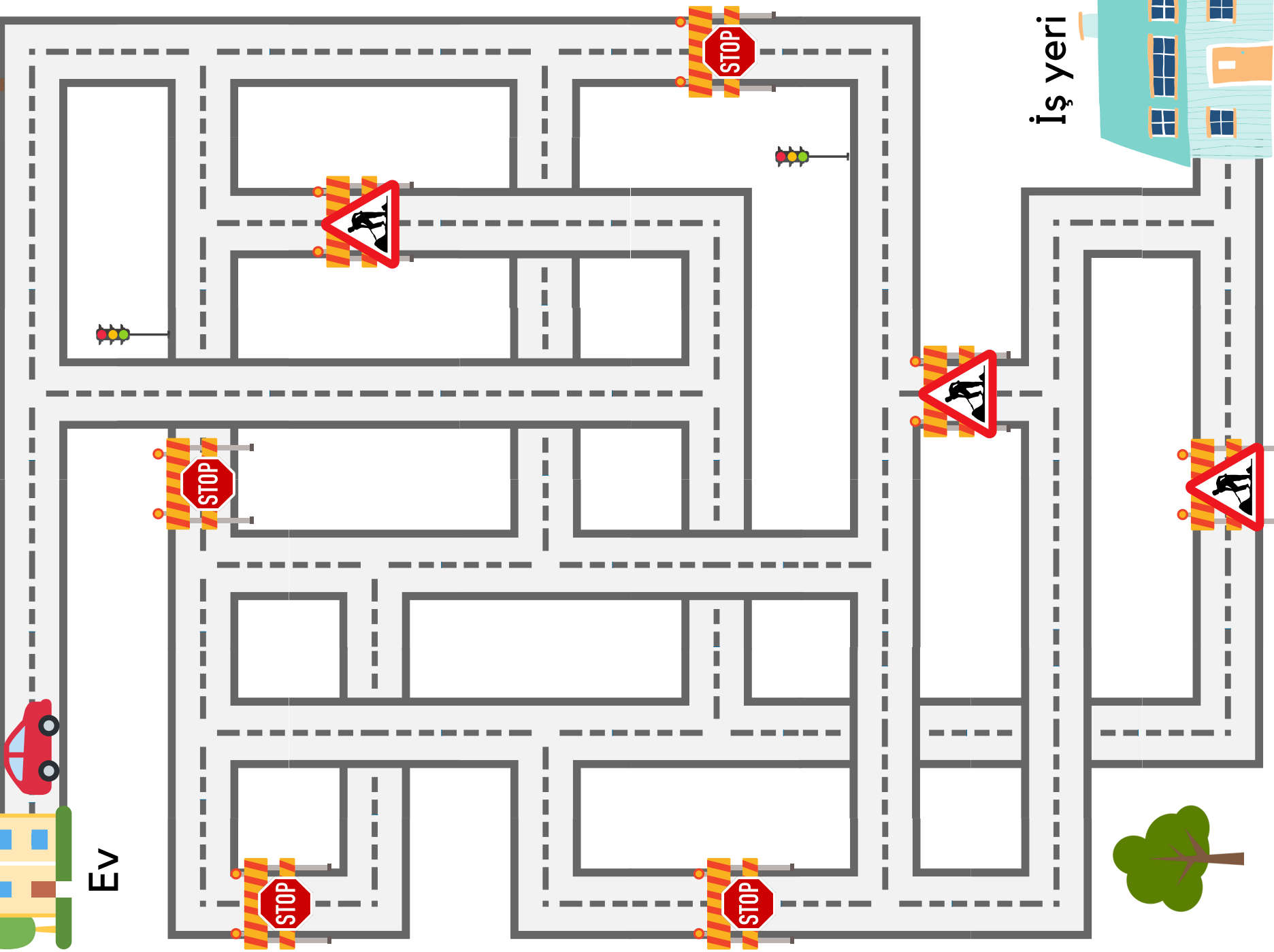
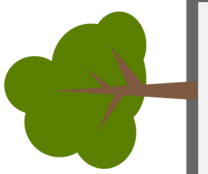

İş yeri

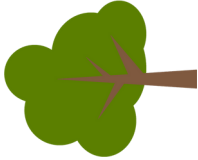
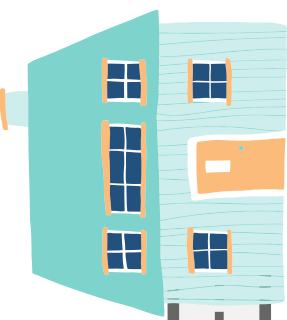

Ambülans

Ambulans, hastaları en kısa yolu kullanarak hastaneye götürmelidir.
Ambulansın önce birinci hastayı, sonra ikinci hastayı alması gerekiyor.



Hastane

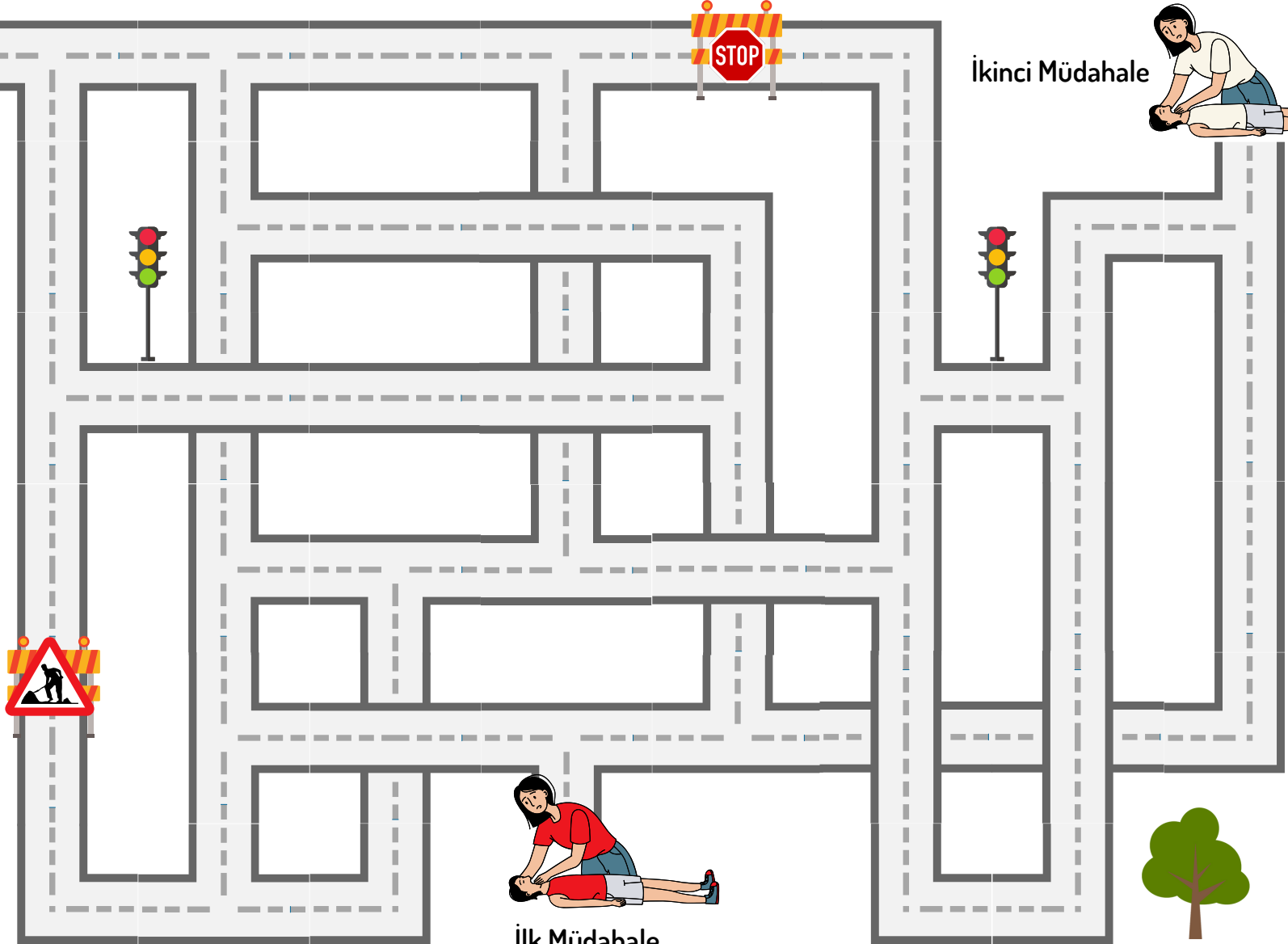

İlk Müdahale

İkinci Müdahale

Mantarlar

Kırmızı mantarın mavi mantara giden yolu bulmasına yardım edelim!

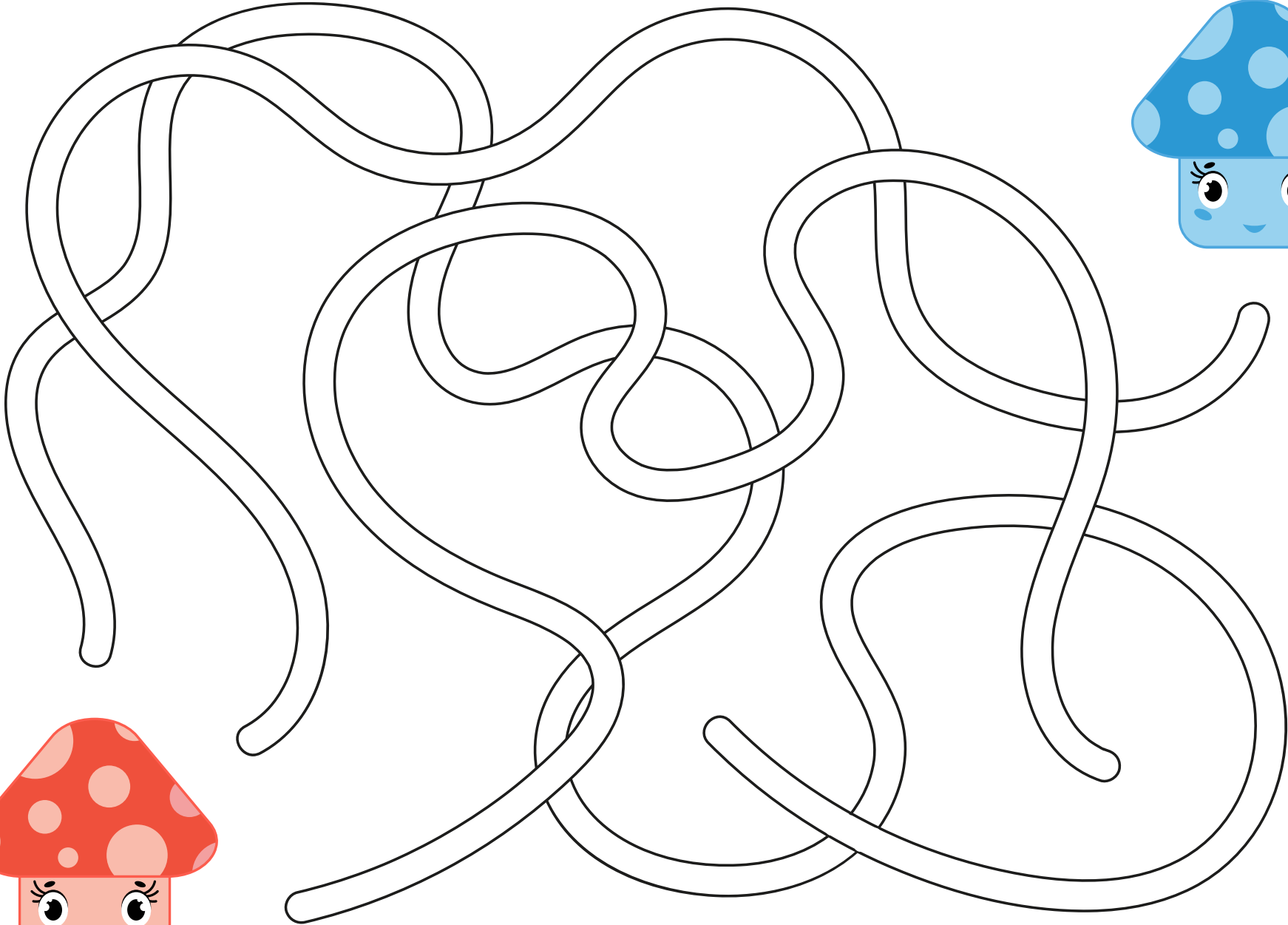

Yolların sonundaki peynirleri kalemlemler renklere göre boyayalım

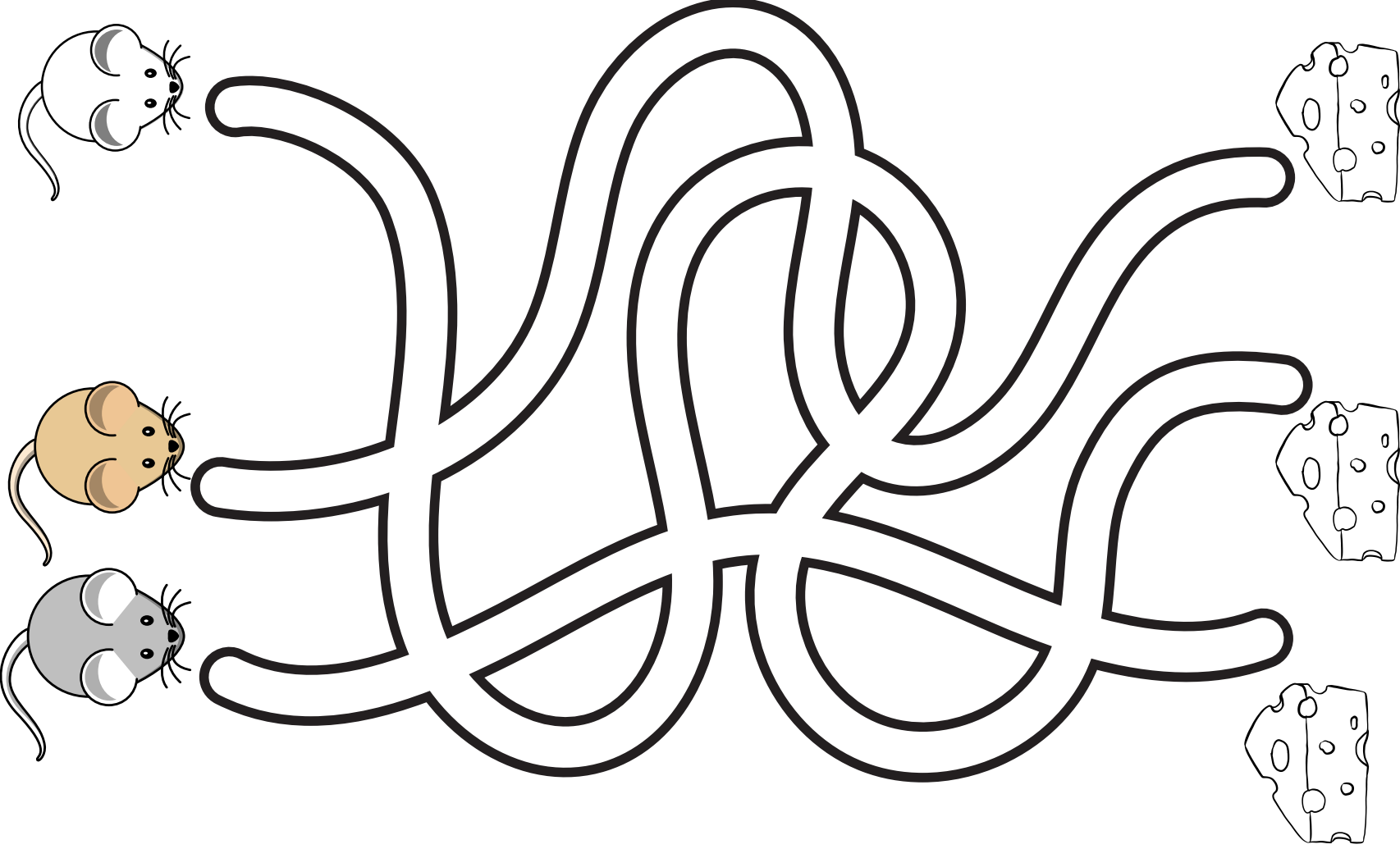
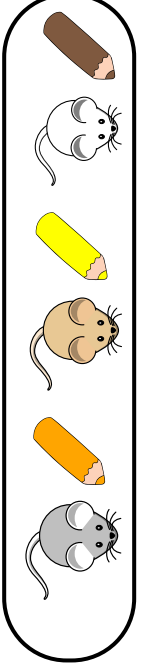

Yolların sonundaki kalpleri uygun renkte boyayalım.

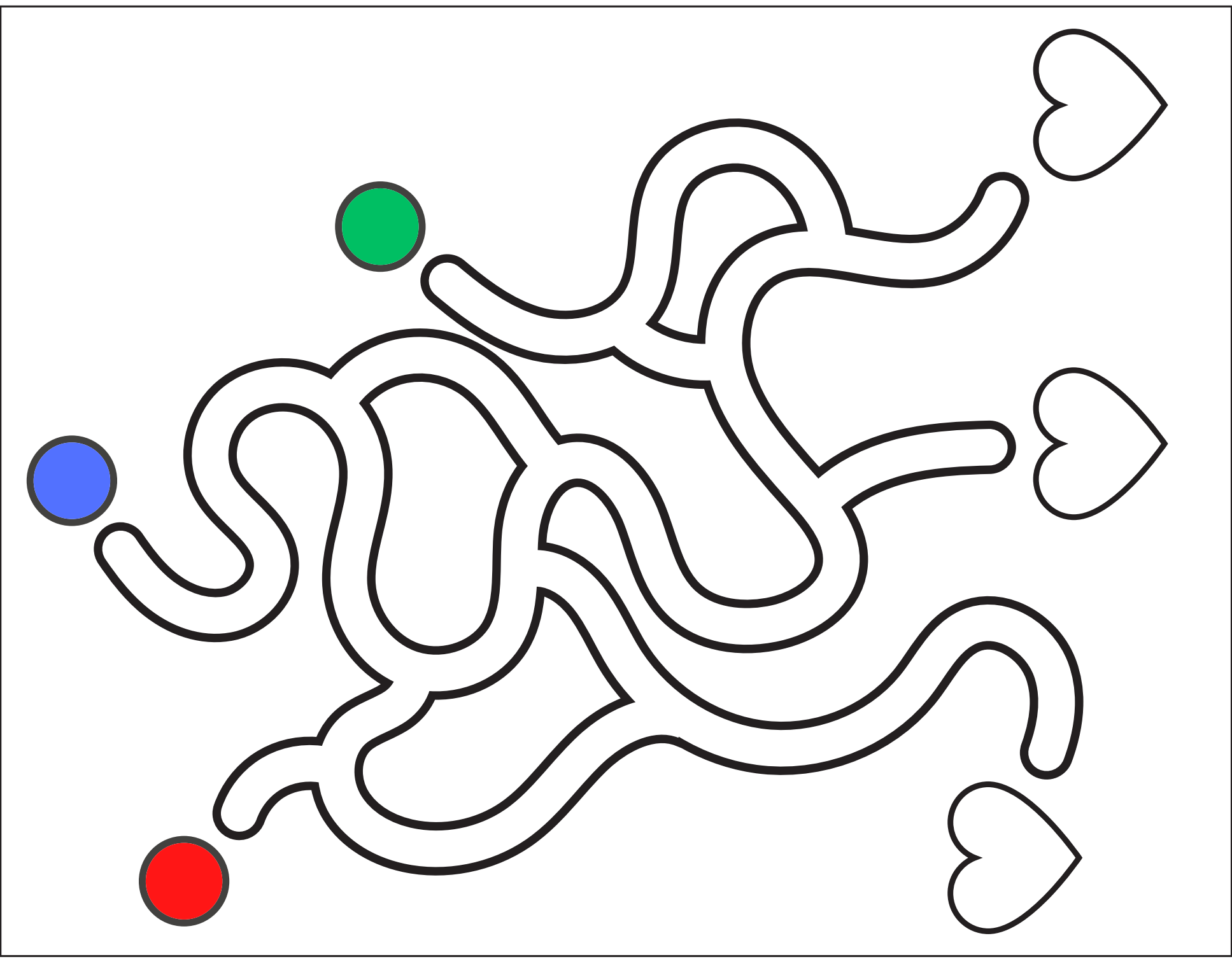

Sağlıklı yiyeceklere giden yolları bulup yeşile boyayalım.

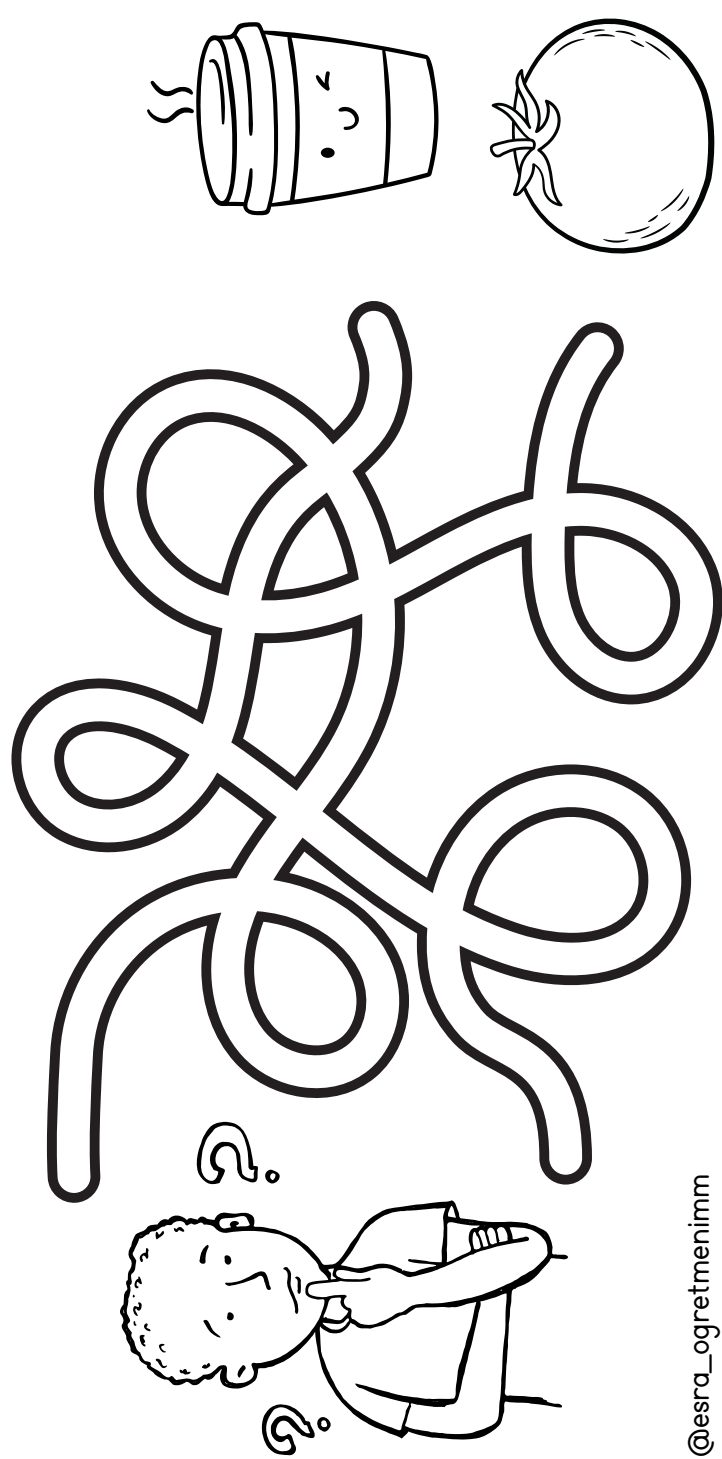
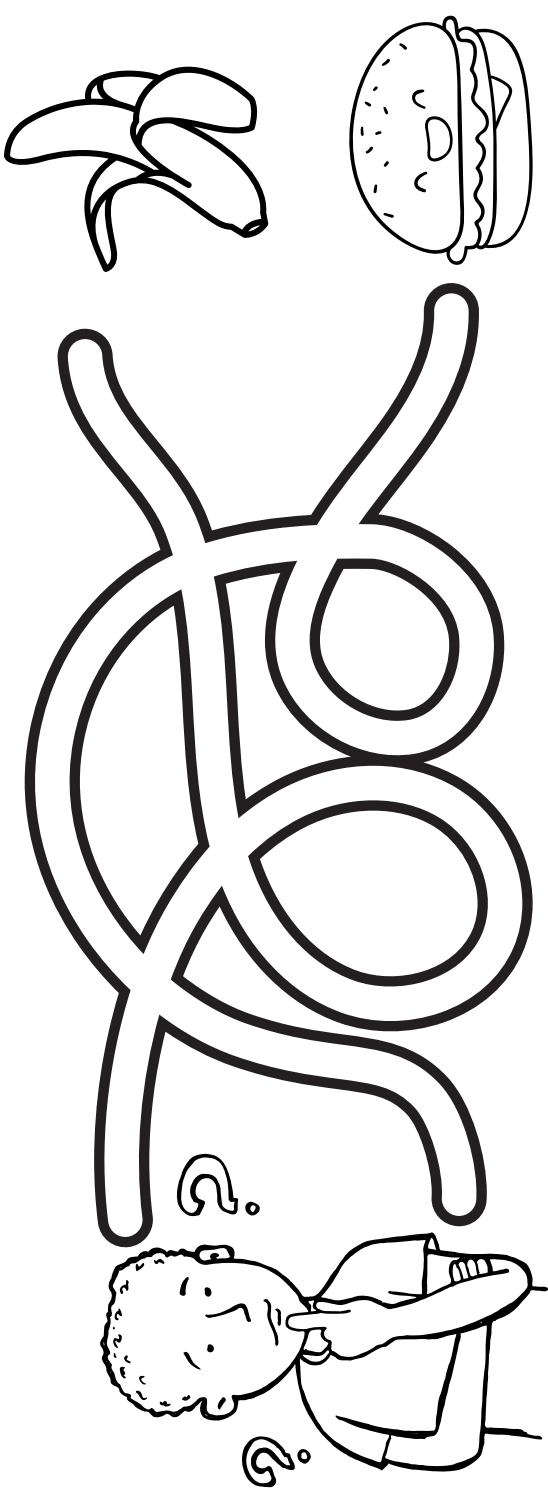
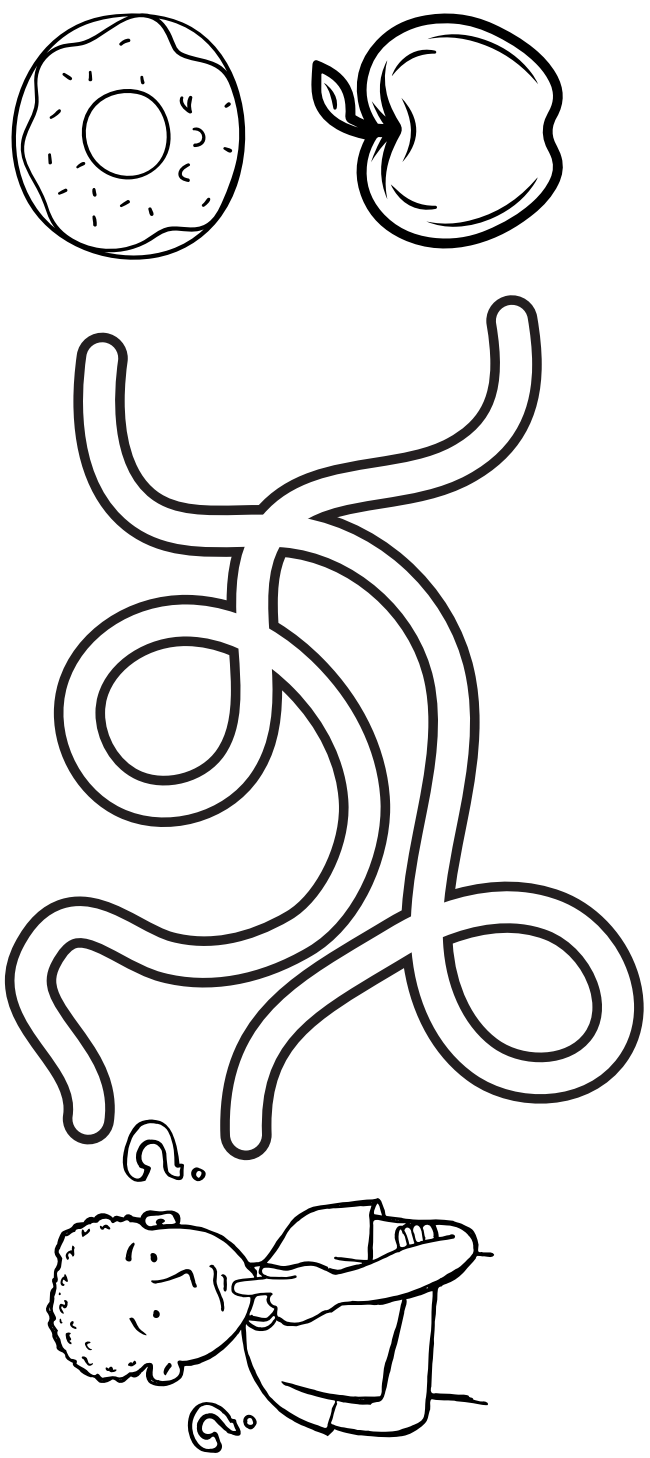

Renkler

Yolların sonundaki şekilleri uygun renge boyayalım.

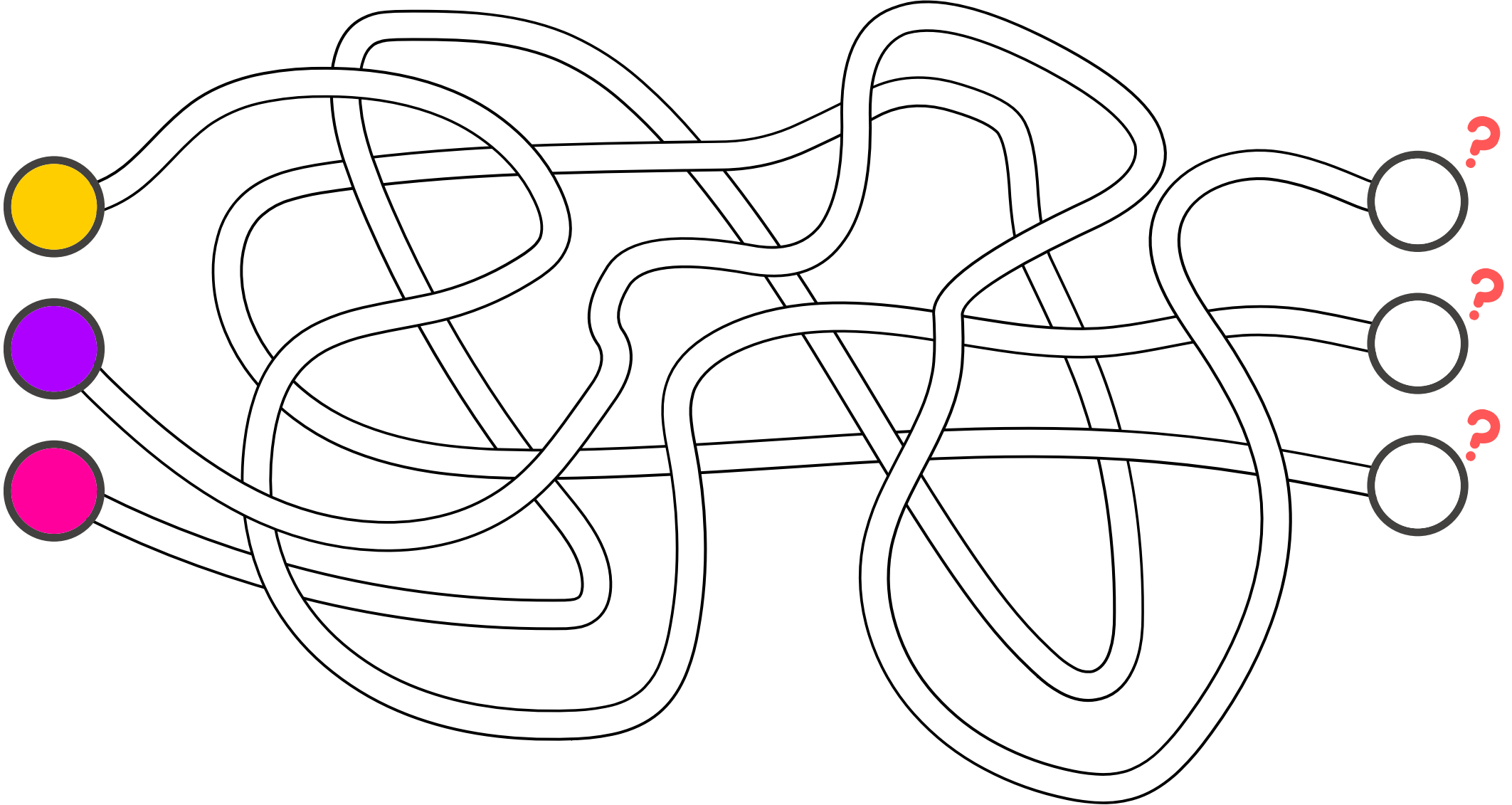

Renkler

Yolların sonundaki şekilleri uygun renge boyayalım.

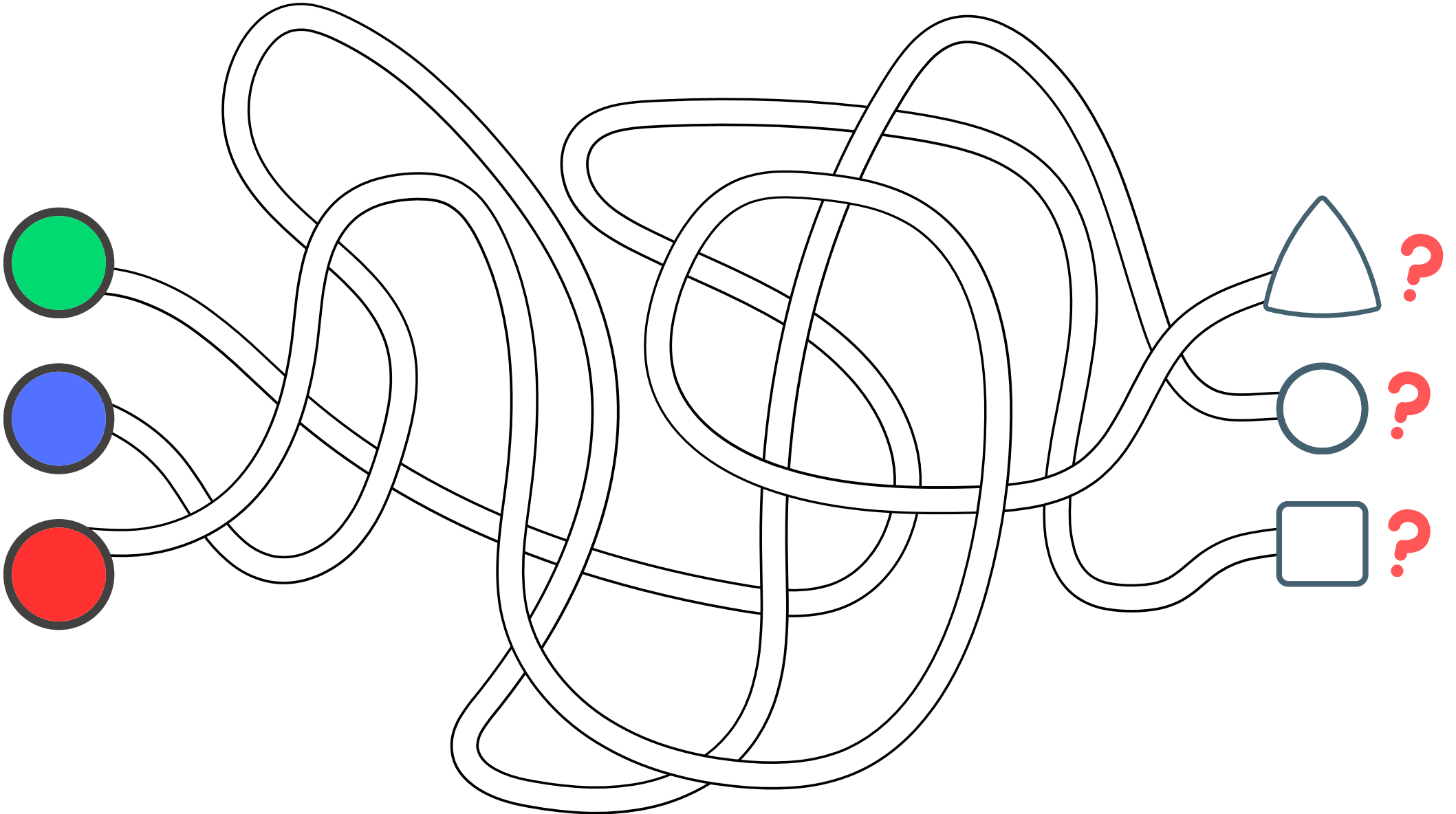

Civciv

Küçük civcivi kümese götürmenin yolunu bulalım ve boyayalım.

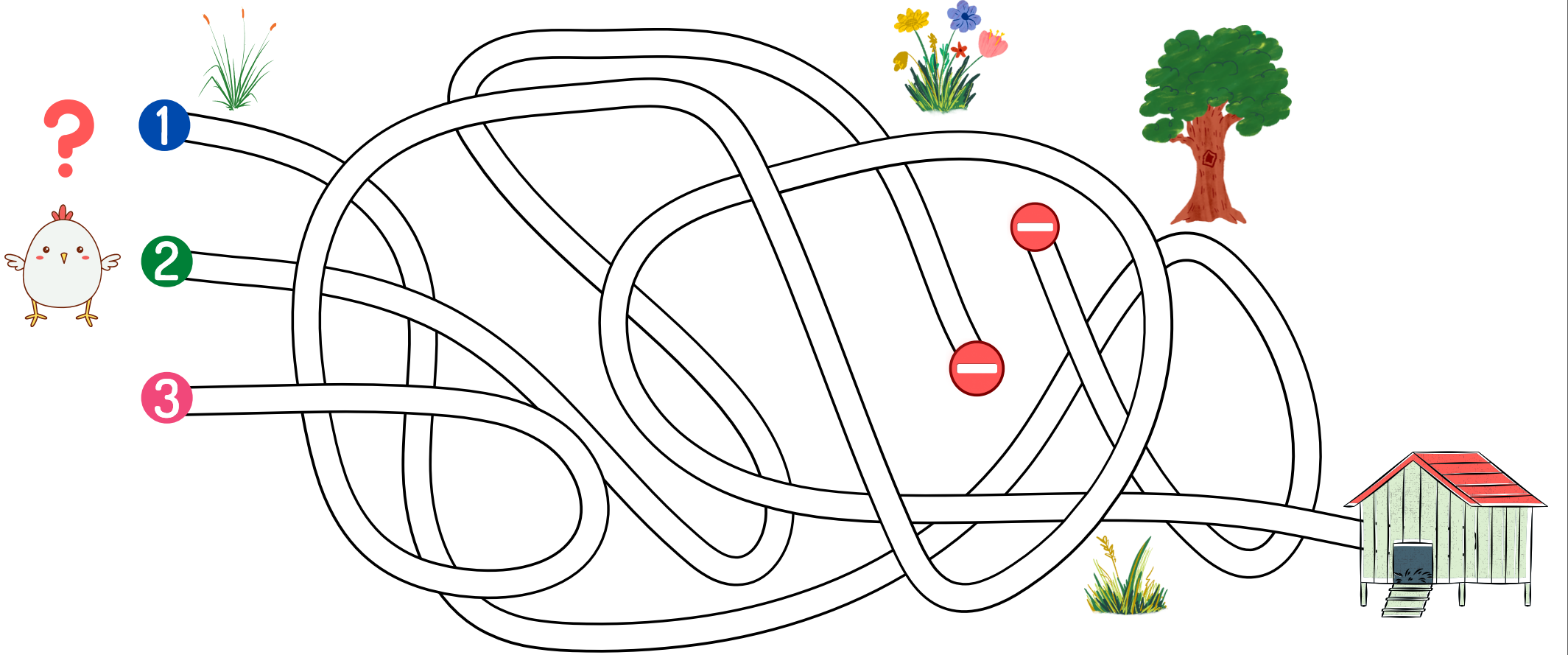

Sevimli Köpek

Köpeęi kemięine götürecek yolu bulalım ve boyayalım.

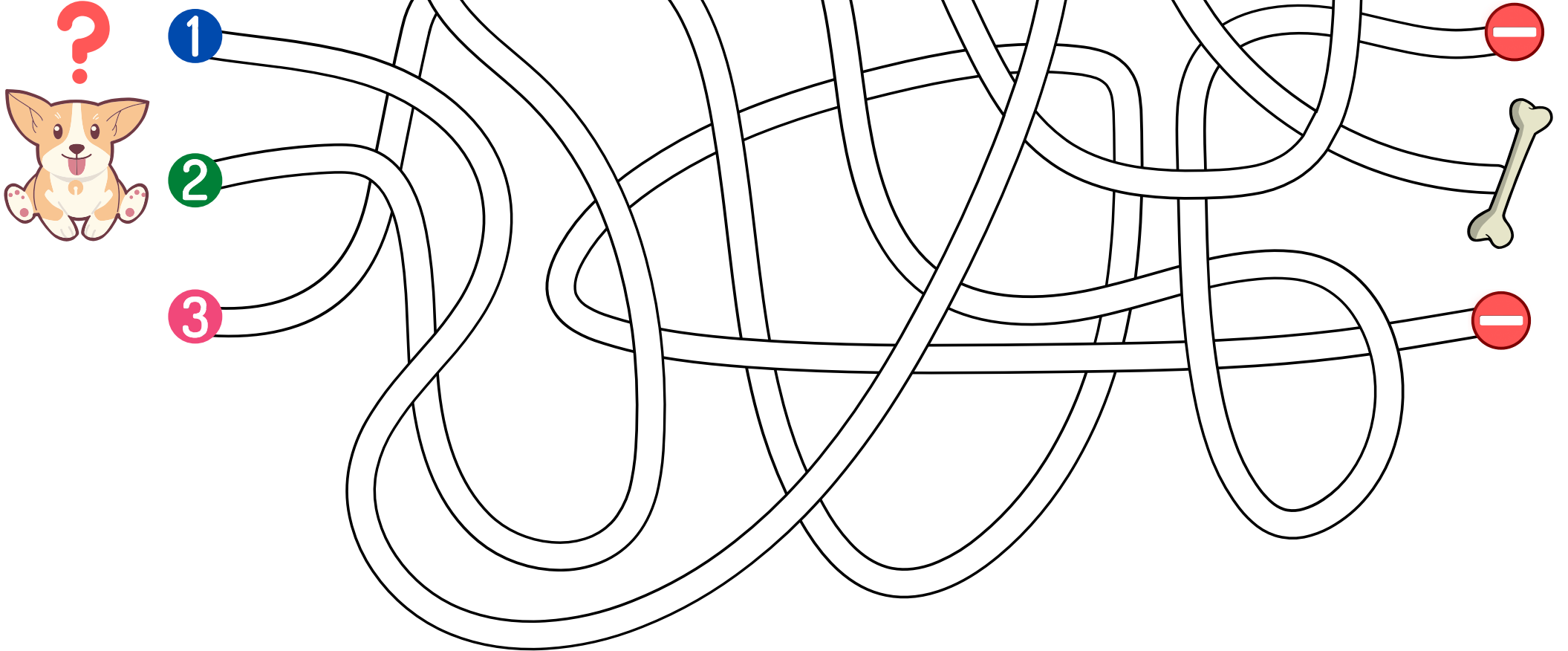

Rakamlar

Yolların sonundaki dairelerin içine uygun sayıları yazalım.

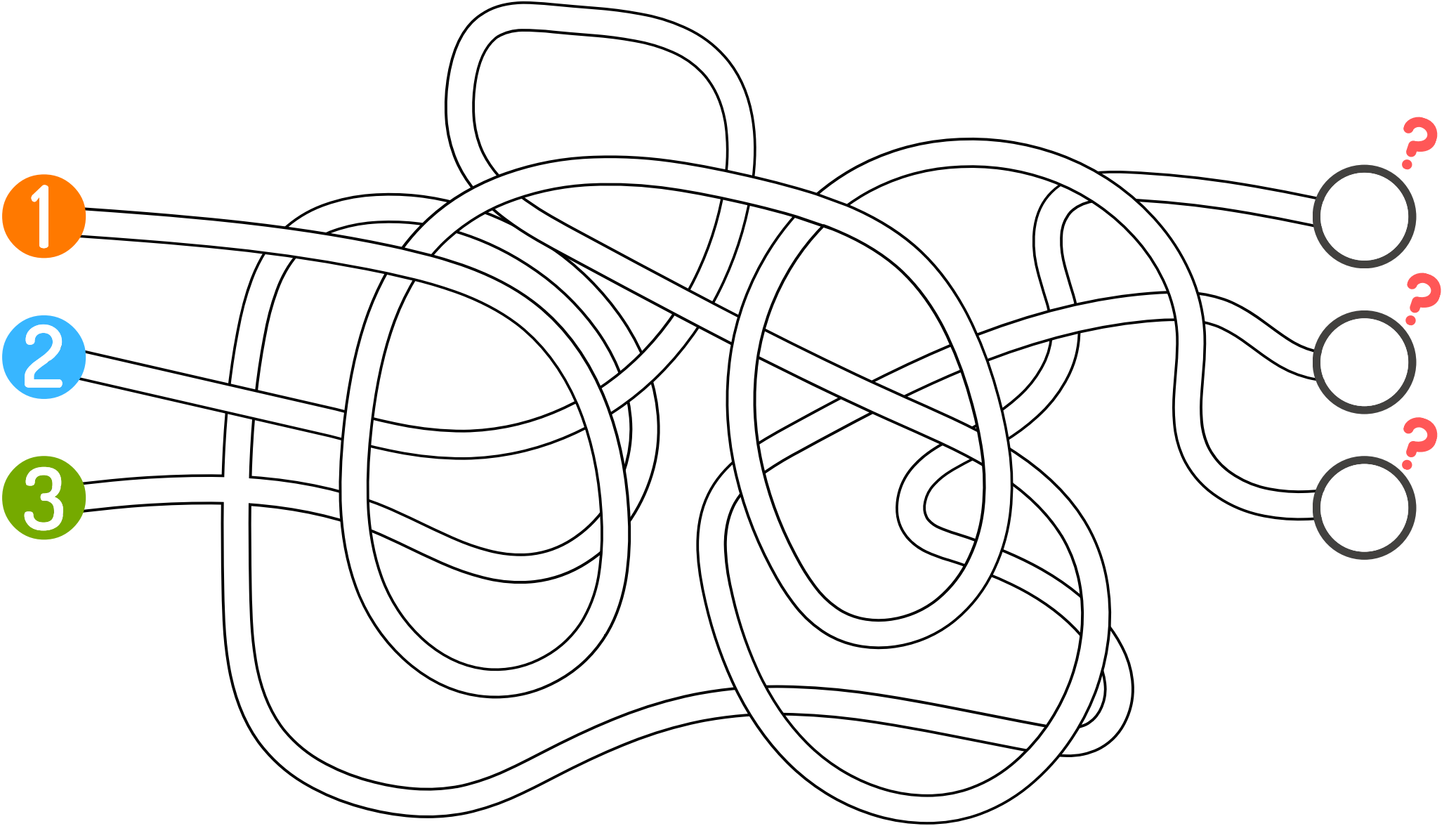

Elektrik Prizleri

Renkli prizler ile aynı renkli lambaları kabloları boyayarak birleştirelim.

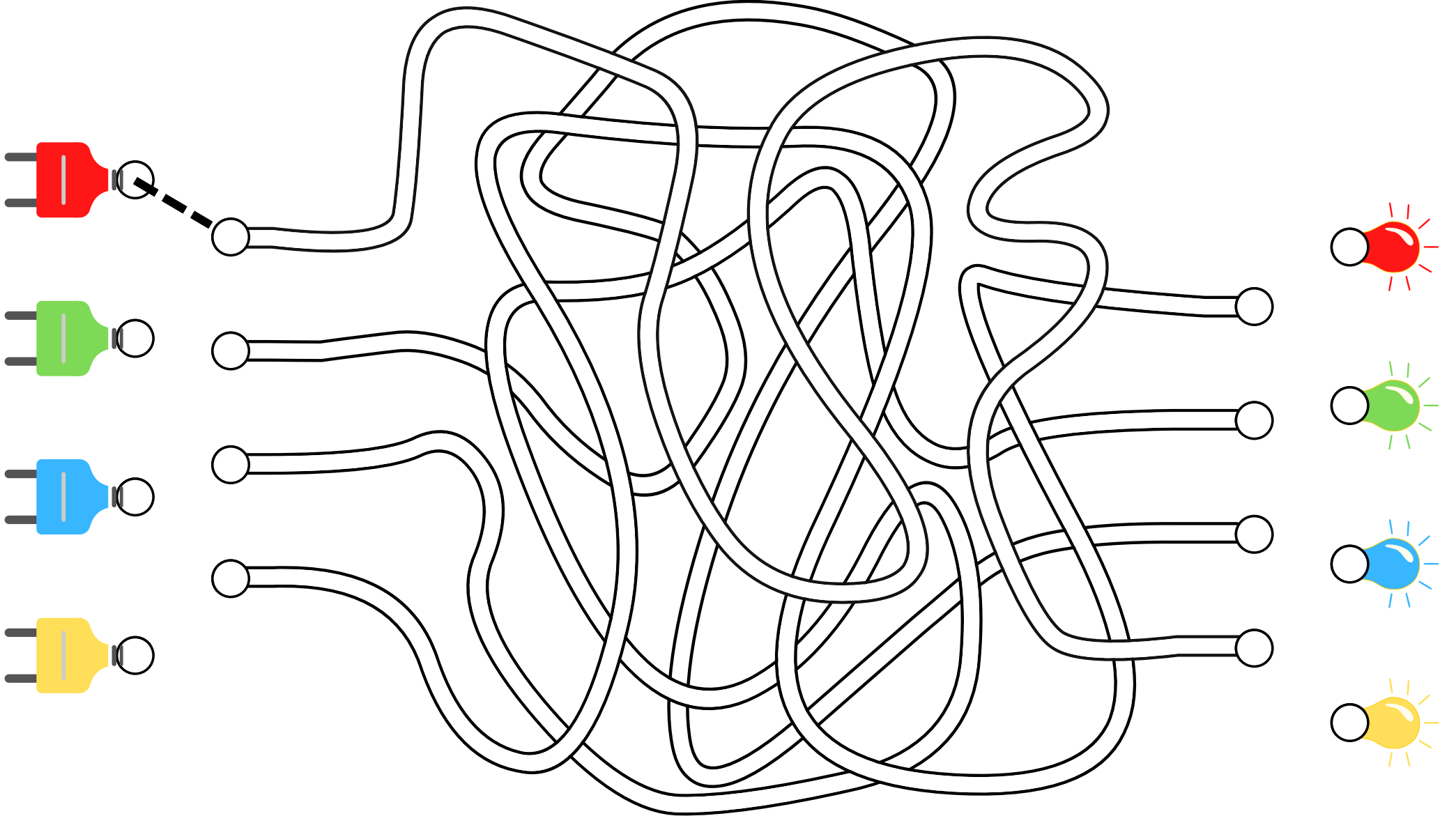

Elmalar

Yolun sonundaki elmaları uygun renklere boyayalım.

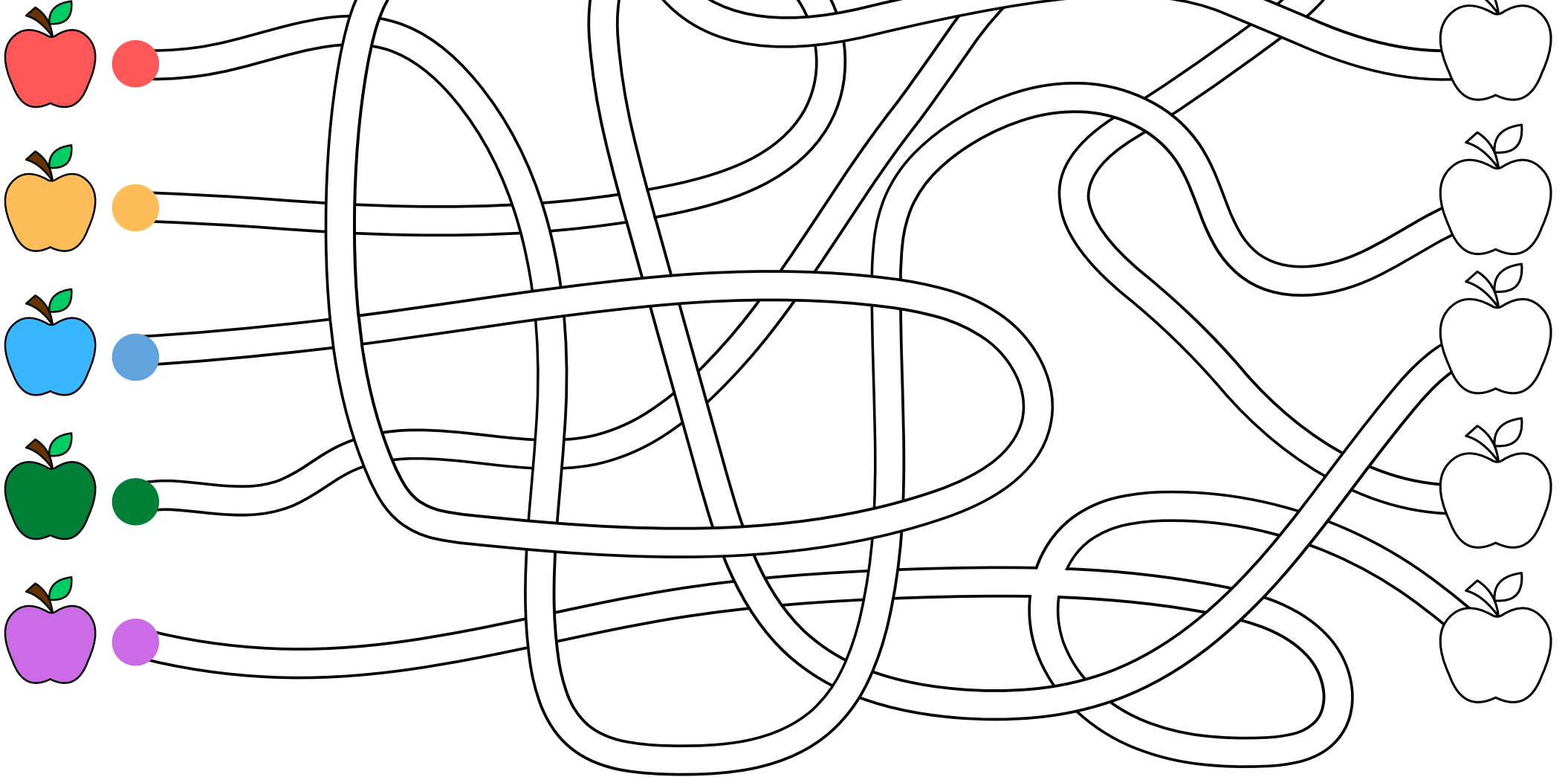

Şekiller

Yolların sonundaki dairelerin içine uygun şekilleri çizelim.

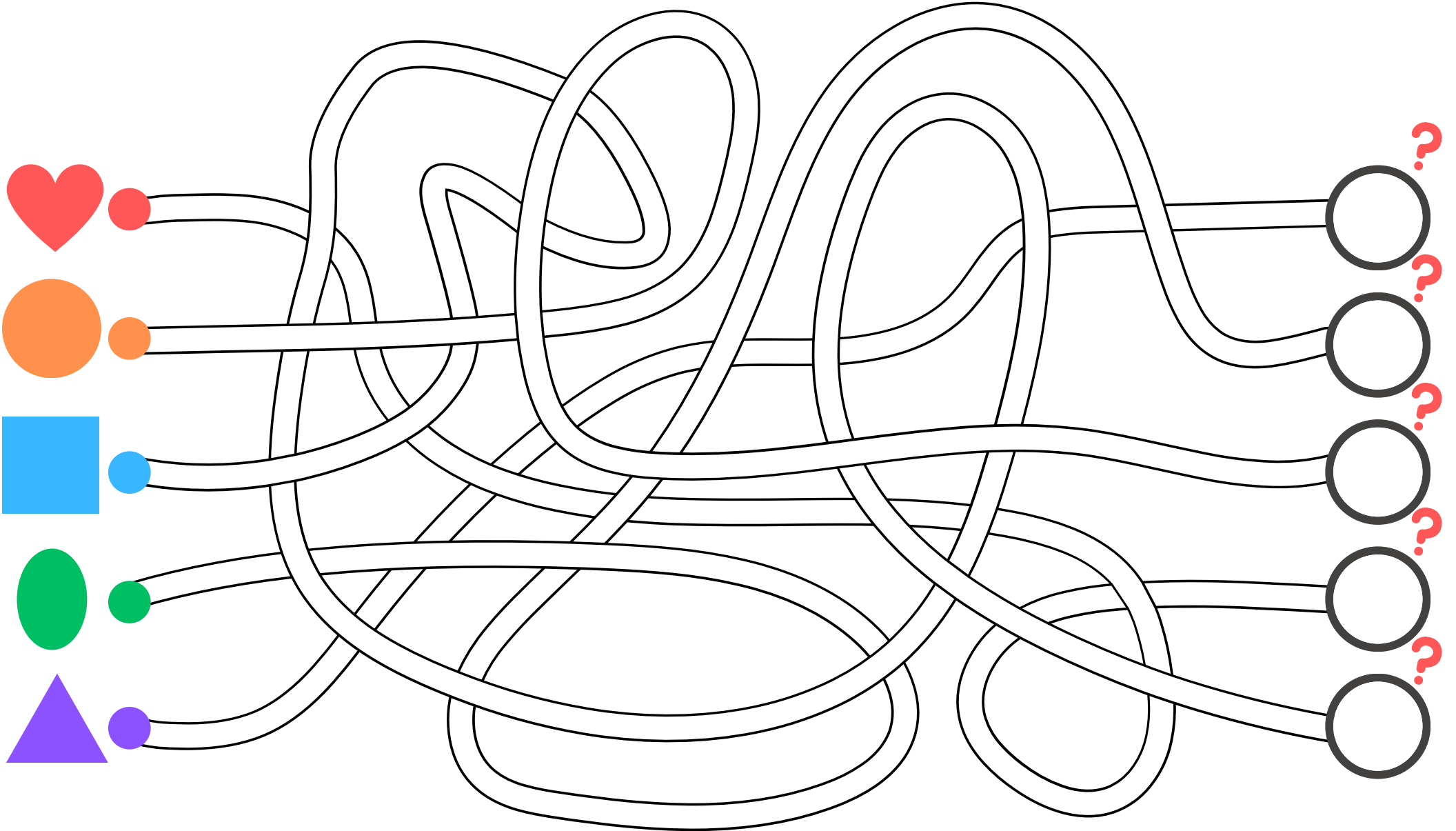

LABİRENT BULMACA

Merhaba, ben Elf. Bana hazineyi bulmamda yardımcı olabilir misin?

