

HECE BİLGİSİ

- Ağzımızın bir hareketiyle söylenen ses veya ses topluluğuna **hece** denir.
- Sesler birleşerek heceleri oluşturur.
- Heceler bir araya gelerek sözcükleri oluşturur.

1. Aşağıda verilen hecelerden örnekteki gibi sözcükler oluşturarak yazalım.

www.eglenerekogrenelim.com

ma vi → ...mavi.....

sa → ...masa.....

kar ne →

ga →

ya zi →

tak →

ke mer →

çi →

ye lek →

şil →

ge mi →

zi →

ter zi →

lik →

ki raz →

vi →

2. Aşağıda verilen heceleri birleştirelim. Anlamli kelimeler oluşturan balonları aynı renge boyayalım. Oluşturduğumuz kelimeleri yazalım.

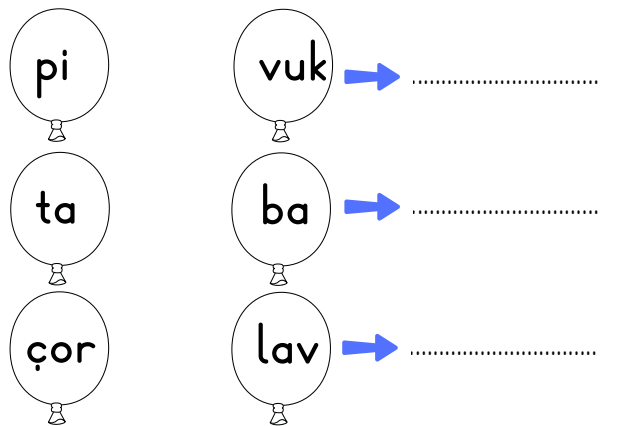
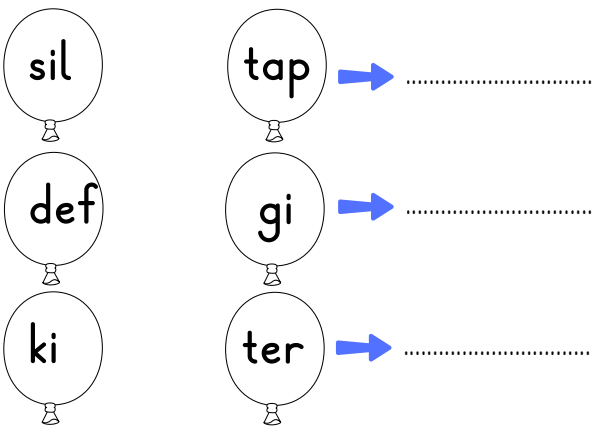
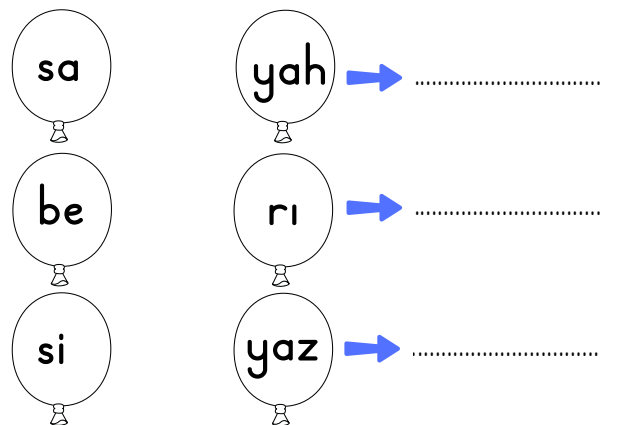
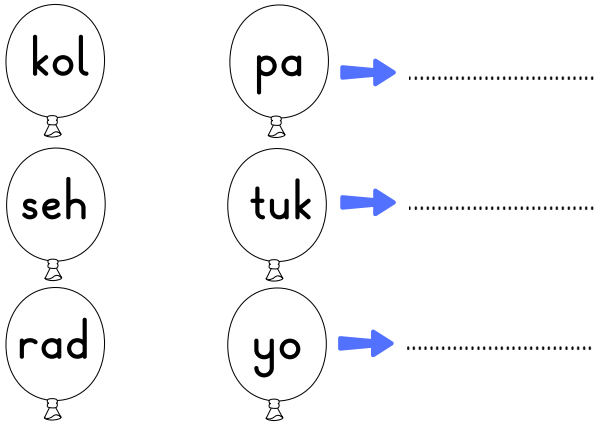
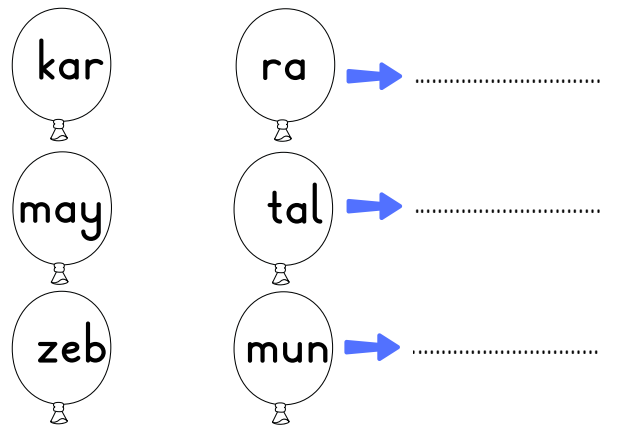
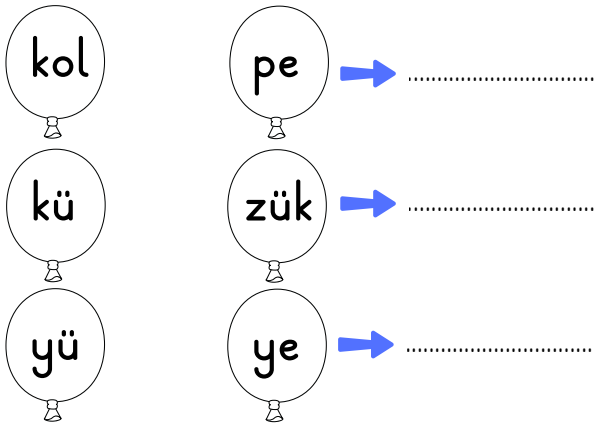
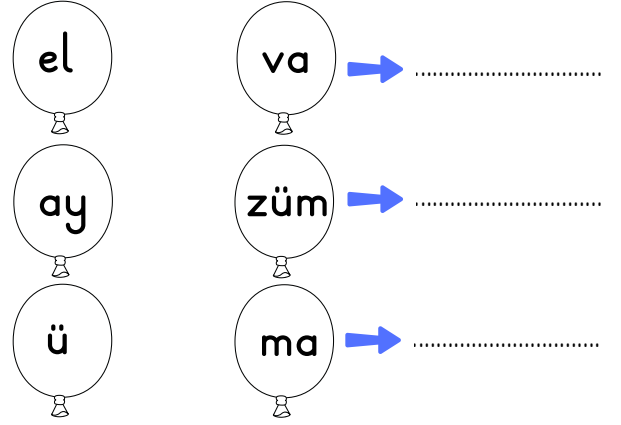
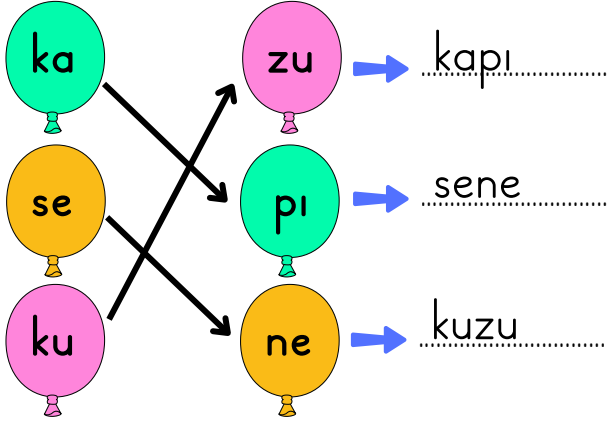

3. Heceleri karışık bir şekilde verilen sözcükleri bularak yazalım.

kan lış ça

calıskan

ya no pi

nek şe me

ya sa ra

E ne dir

ba na li

li se vim

ren ci öğ

tan İs bul

zel be ye

Nes han li

hi ra sü

tap lık ki

dar jan ma

pi sa ra

ci mer mek

noz ka va

fa zü ra

Be taş şik

ja ma pi

na ma kar

ce re ten

cu tu run

çı van bah

HECELEME

• Bir sözcüğün hecelerini teker teker söylemeye **heceleme** denir.

• Sözcükleri hecelerken heceler arasında **kısa çizgi (-)** konur.

Örnek: kedi → ke-di armut → ar-mut

1. Aşağıdaki görsellerin isimlerini yazalım. Örnekteki gibi isimleri hecelerine ayırarak hece sayılarını yazalım.

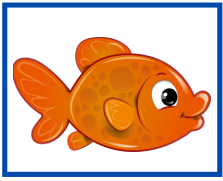

balık
ba-lık



.....
.....

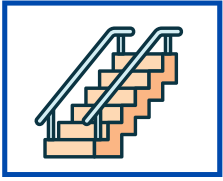

.....
.....

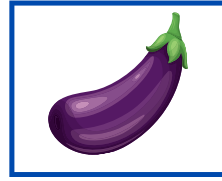

.....
.....



.....
.....



.....
.....



2. Aşağıda verilen hecelerden örnekteki gibi sözcükler oluşturup yazalım.

portakal →

por-ta-kal

toprak →

.....

eldiven →

.....

yağmur →

.....

mor →

.....

erkek →

.....











fare →











.....

süpürge →

.....

Görseli verilen kelimeleri heceleyerek yazalım. Sonra da hece sayısını yazalım.

Görseller	Heceleme	Hece Sayısı
	şap-ka	2
		
		
		
		
		
		
		
		
		
		

Görseller	Heceleme	Hece Sayısı
		
		
		
		
		
		
		
		
		
		
		

Görsellerin adını heceleyerek kutuya yazalım. Sonra da hece sayısını yazalım.



pa-pat-ya 3

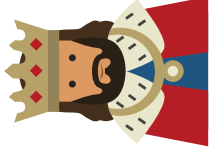
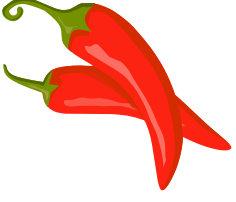
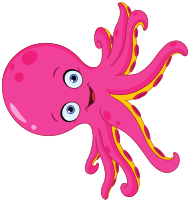

HECE SAYISI

- Kelimelerdeki hece sayısını bulurken önce kelimeyi hecelerine ayırırız.

Tek heceli kelimeler:

Türk, muz, su, mont, sert, tren, park, spor, kral, prens.

İki heceli kelimeler:

Türkçe, mutfak, okul, kiler, sokak, bidon, çiçek.

Üç heceli kelimeler:

Atatürk, kitapçı, zürafa, kırmızı, hediye, bisiklet.

1. Aşağıdaki sözcükleri hece sayılarına göre gruplayalım.

kuşak	tank	tiyatro	çamaşır	kalk
fark	ilaç	ders	dağınık	mutfak
görev	perde	marangoz	tuz	Atatürk

Tek Heceli Sözcükler

.....

.....

.....

.....

.....

İki Heceli Sözcükler

.....

.....

.....

.....

.....

Üç Heceli Sözcükler

.....

.....

.....

.....

.....

2. Aşağıdaki kelimelerden, hecelerine doğru ayrılanların kutusunu boyayalım.

it-fa-iy-e

it-fa-i-ye

it-fa-iy-e

li-mon-a-ta

lim-on-at-a

li-mo-na-ta

tek-er-le-me

te-ker-le-me

te-ker-lem-e

sin-e-ma

si-nem-a

si-ne-ma

mak-ar-na

ma-kar-na

ma-ka-r-na

ti-yat-ro-cu

tiy-at-ro-cu

ti-yat-roc-u

la-civ-ert

la-ci-vert

lac-iv-ert

te-le-viz-yon

te-lev-iz-yon

tel-ev-iz-yon

hel-i-kop-ter

hel-ik-op-ter

he-li-kop-ter

HECELEME

- Türkçemizde her hecede sadece **bir sesli harf** bulunabilir.
- Heceler en az bir harften oluşur.
- En çok ise dört harften oluşur.

o-kul



tek harfli hece

ko-yun



iki harfli hece

kart-lık



dört harfli hece

1. Hecelerdeki harf sayılarını bularak altlarına yazalım. Hecelerle oluşan kelimeleri örnekteki gibi yanına yazalım.

büs

o

to



otobüs

3

1

2

kir

çe

ge



ğ

ba

kur



gu

kan

ru



ba

na

li



mes

kü



lak

oğ



yik

ge



di

hin



ril

go



Hece Sayısını Bulma

- Kelimedeki hece sayısı, kelimedeki ünlü harf sayısı kadardır.
- Ünlü harfler tek başına hece olabilir.
- Bir sözcüğün kaç heceden oluştuğunu bulmak için sözcükteki sesli harfleri sayabiliriz.

temiz → 2 heceli

tiyatro → 3 heceli

e-i → 2 ünlü harf var.

i-e-i → 3 ünlü harf var.

1. Aşağıda verilen görselin adını yazalım. Örnekteki gibi ünlü harflerini yazarak hece sayılarını bulalım.

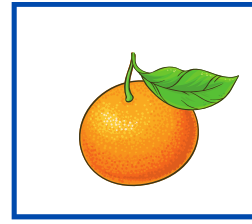
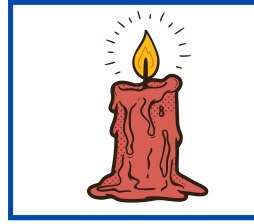
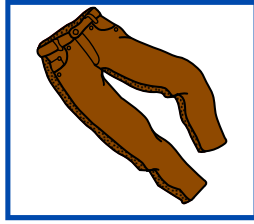
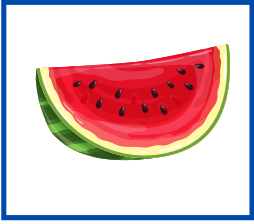

.....karpuz.....

.....a-u.....

2



2. Aşağıda verilen sözcüklerin ünlü harflerini bularak hece sayılarını örnekteki gibi yazalım.

.....içecek.....

.....i-e-e..... → 3

.....uzaklık.....

..... →

.....yurt.....

..... →

.....cami.....

..... →

.....traktör.....

..... →

.....keloğlan.....

..... →

.....son.....

..... →

.....terminal.....

..... →