

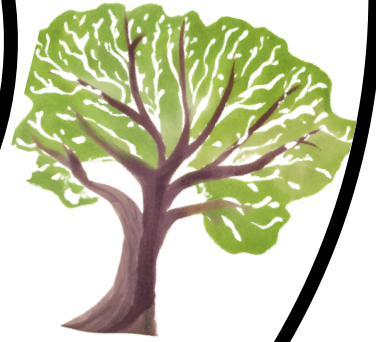

“a – A”  
Sesini  
Öğreniyorum



## “ a – A ” Sesini Ayırt Etme

- Adında “ a ” sesi olan varlıkların altındaki kutucukları boyyalım.

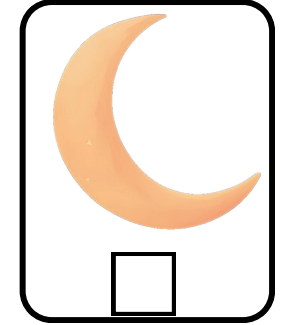
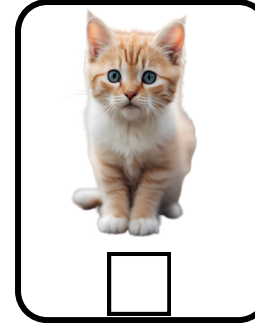
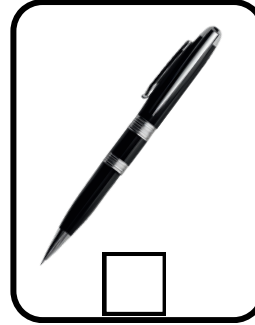
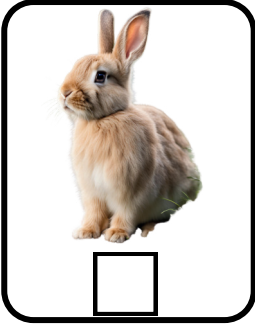
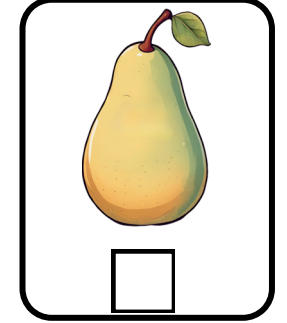
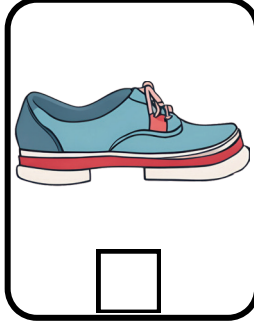
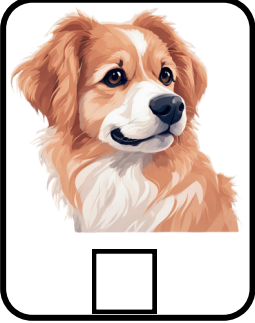
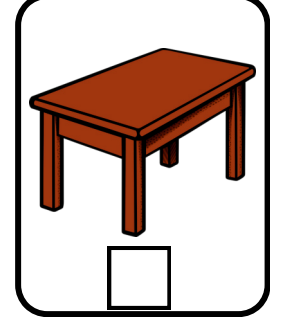
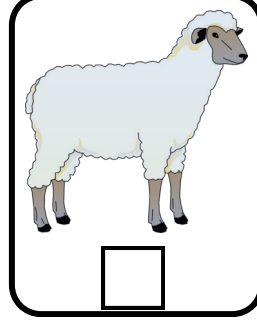
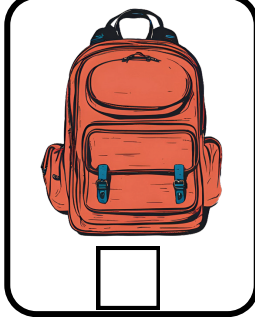
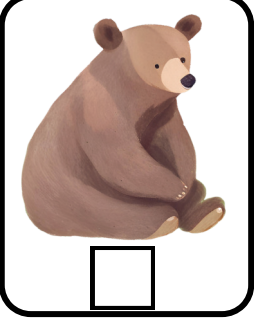

- Aşağıdaki varlıkların adında “ a ” sesi baştaysa 1. kutuyu, ortadaysa 2. kutuyu, sonda ise 3. kutuyu boyyalım.

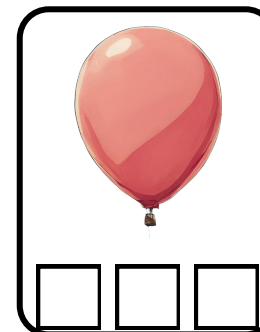
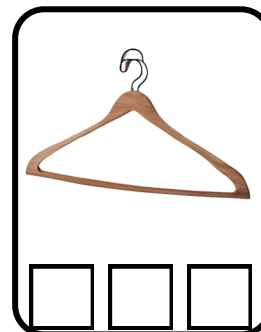
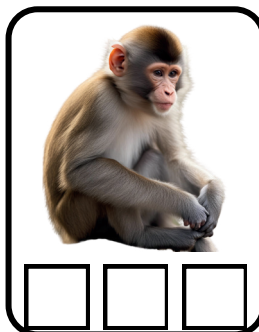
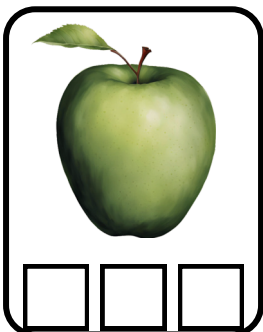

# “a – A” Sesini Okuyup–Yazalım

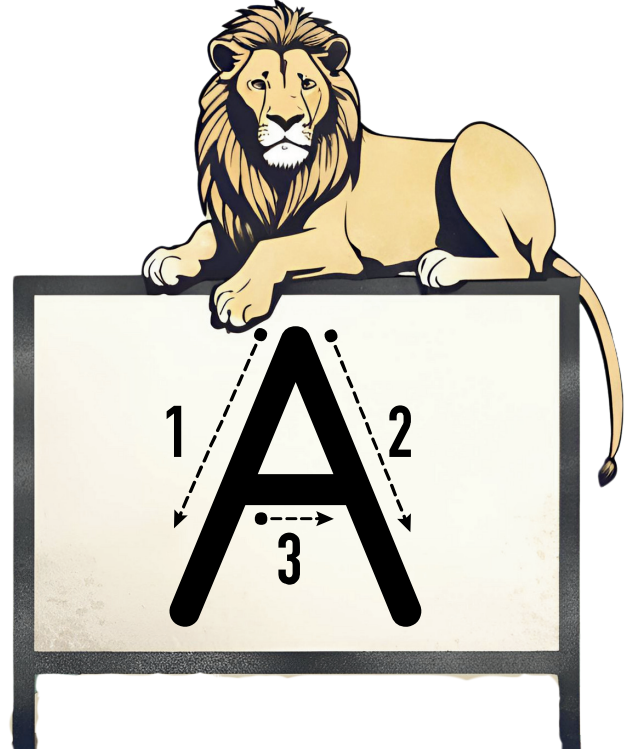
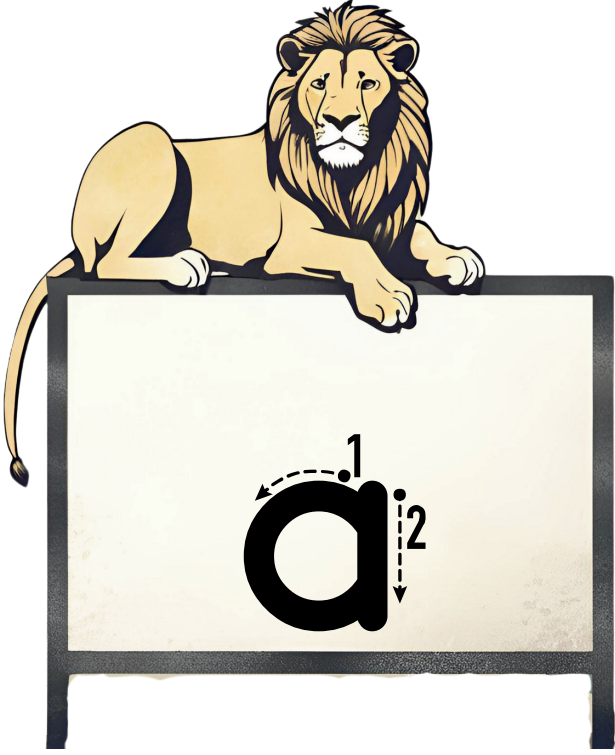

- “a – A” harflerini yazalım, yazdığımız harfi söyleyelim.

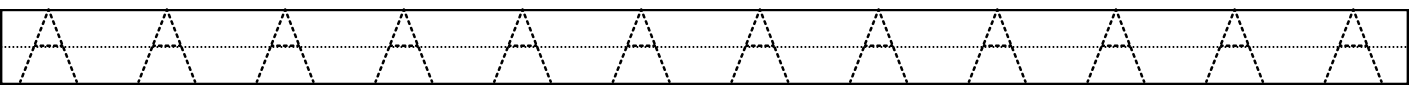
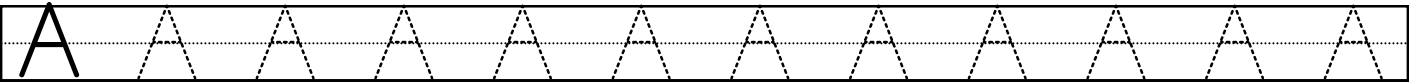
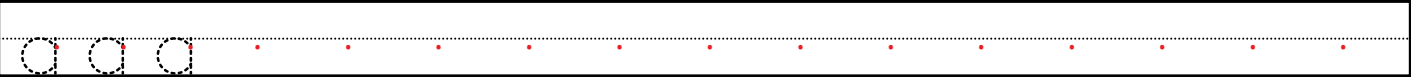
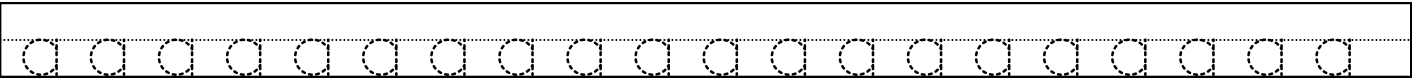
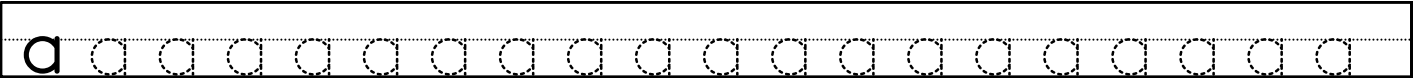

- Aşağıdaki görsellerin ne olduğunu söyle, "a" sesini bul, daire içine al.



a y ı



a ğ a ç



a s k ı



a n a h t a r

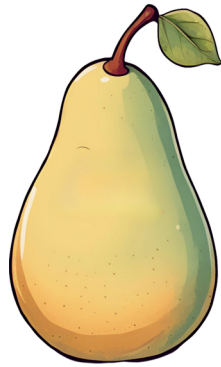

a r m u t



a y a k k a b ı

- " a " harflerini yazalım.

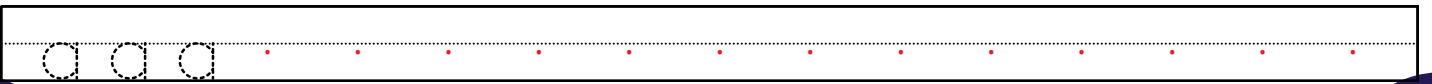
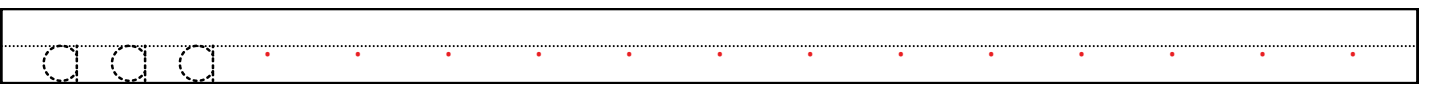
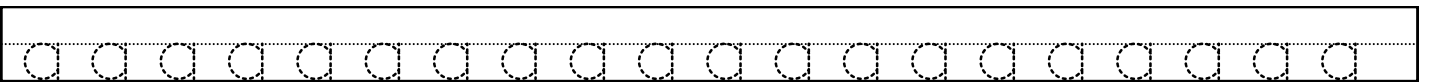

- Aşağıdaki görsellerin ne olduğunu söyle, "a" sesini bul, daire içine al.



elma



balta

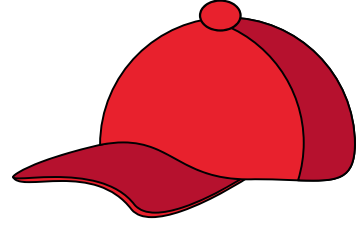

şapka

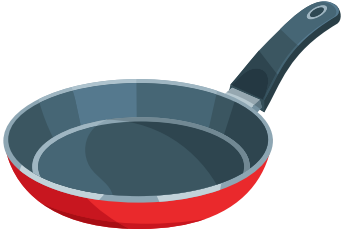

tava



limonata



kurbağa

- "a" harflerini yazalım.

a a

a a a . . . . .

a a a . . . . .

- “ a ” harflerini yazalım.

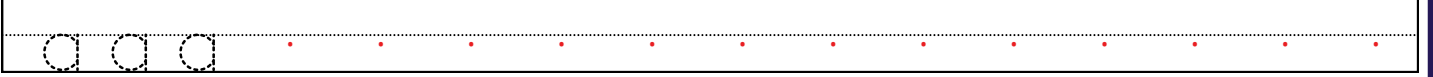
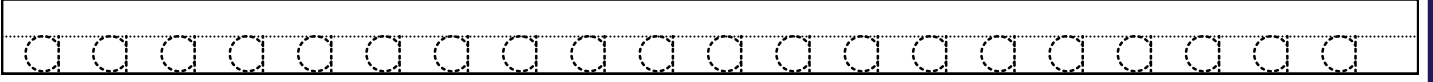

- Çizgi ile “ a ” harfini takip ederek çocuęu evine ulařtıralım.

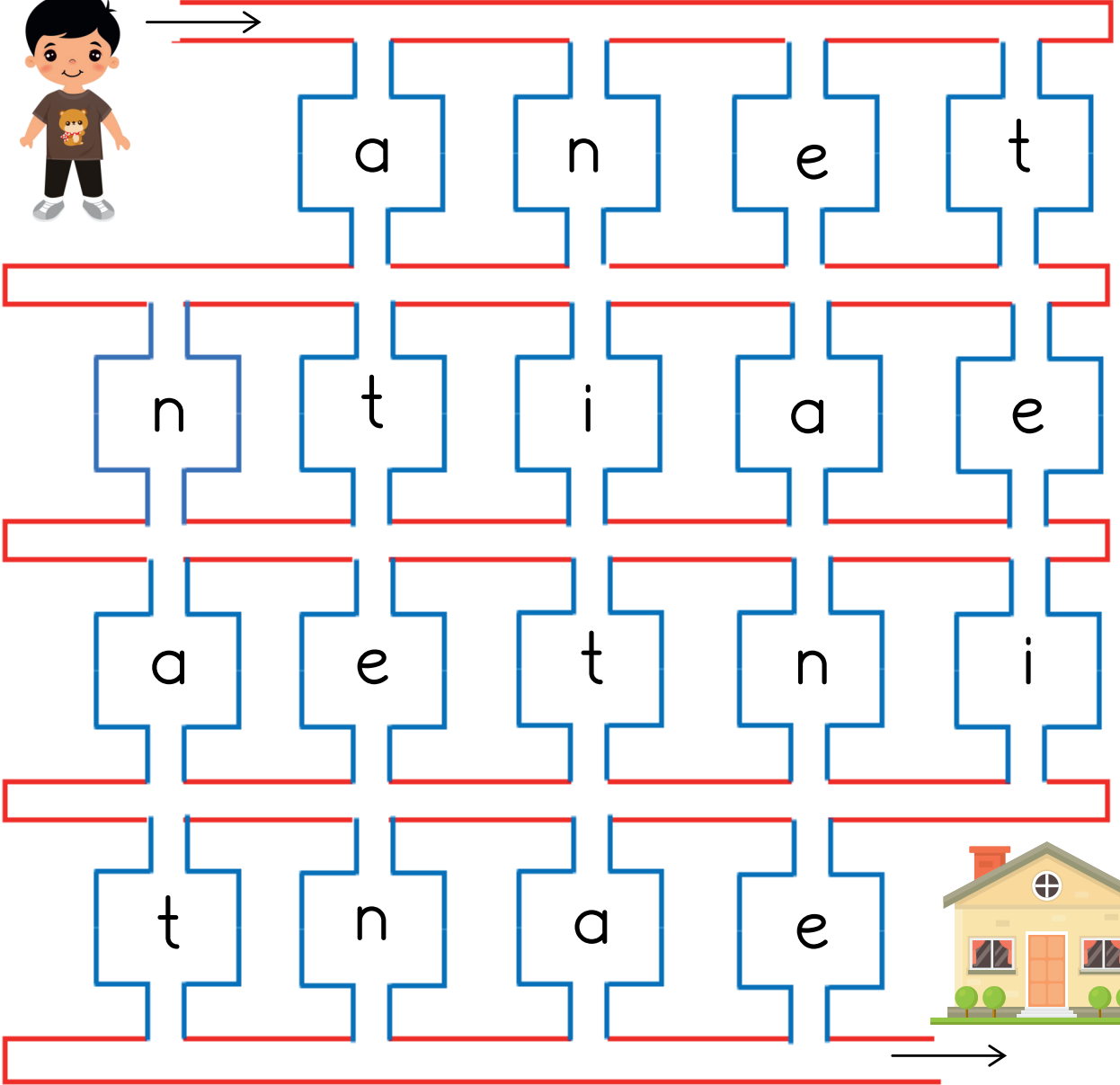

- Başlangıç noktasından başlayıp küçük ve büyük "a" harflerini boyayarak arabayı garaja ulaştırınız.



a	A	a	a	s	T	y	m
E	l	s	A	i	O	k	u
k	K	e	A	a	a	a	ç
M	o	v	b	y	v	A	ş
m	i	L	e	C	P	A	D
Z	A	a	a	a	a	A	z
c	A	y	ç	G	o	p	ğ
ö	A	a	a	a	a	a	a



- "a - A" harflerini yazalım, yazdığımız harfi söyleyelim.

a a

a a a . . . . .

a a a . . . . .

A A A A A A A A A A A A A A A A

A A A . . . . .

• “a – A” harflerini yazalım, yazdığımız harfi söyleyelim.

a a

a a

a a a . . . . .

a a a . . . . .

a a a . . . . .

a a a . . . . .

A A A A A A A A A A A A A A A A

A A A A A A A A A A A A A A A A

A A A . . . . .

A A A . . . . .

A A A . . . . .

A A A . . . . .

“n – N”  
Sesini  
Öğreniyorum

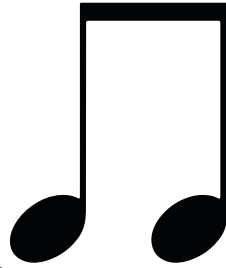
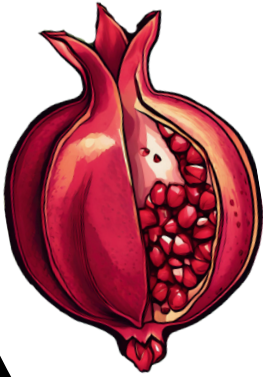

## “ n – N ” Sesini Ayırt Etme

- Adında “ n ” sesi olan varlıkların altındaki kutucukları boyyalım.

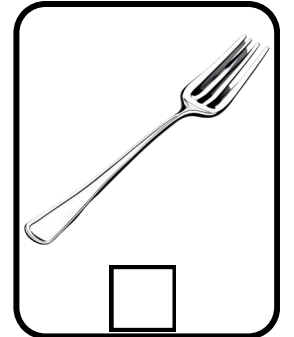
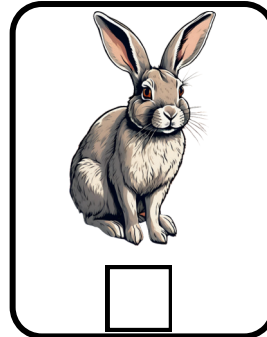
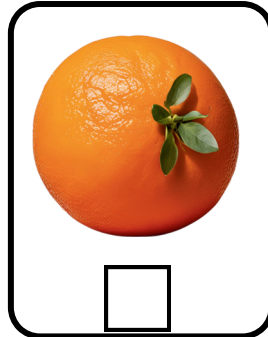
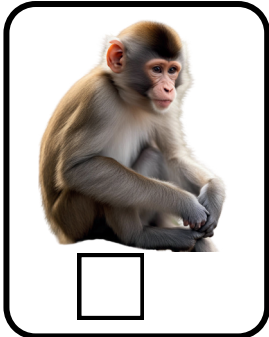
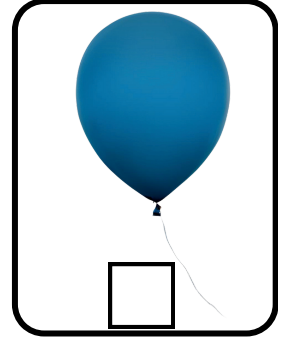
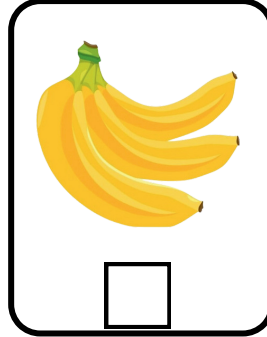
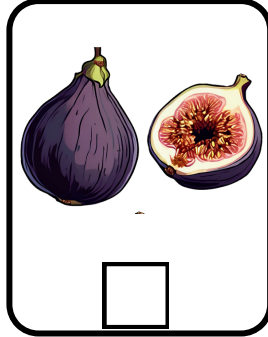
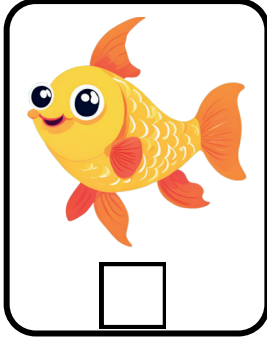
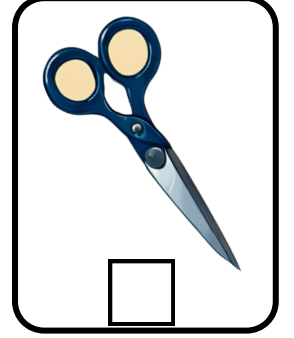
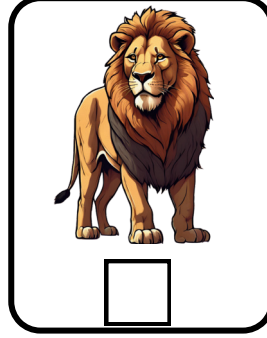
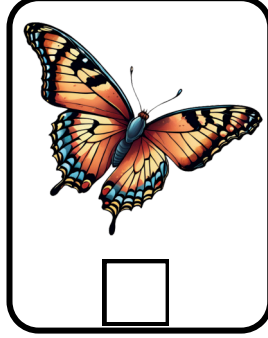
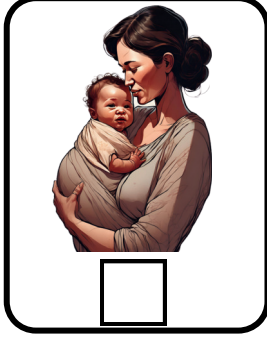
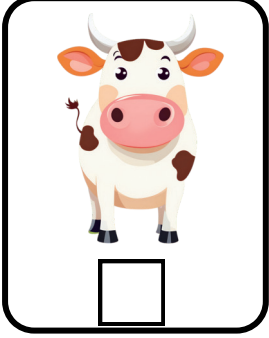

- Aşağıdaki varlıkların adında “ n ” sesi baştaysa 1. kutuyu, ortadaysa 2. kutuyu, sonda ise 3. kutuyu boyyalım.

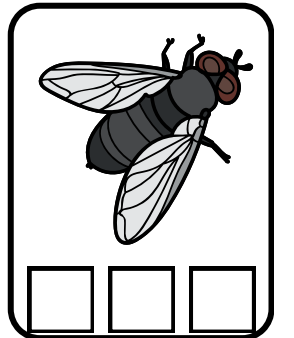
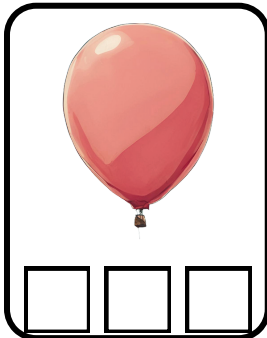
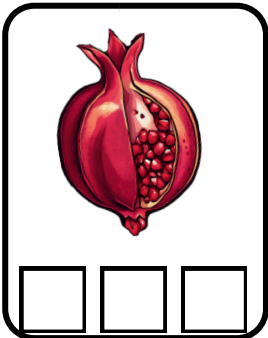
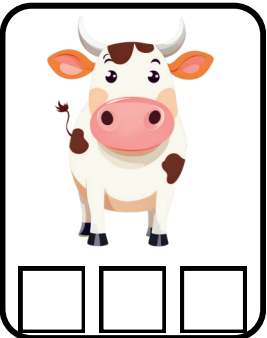
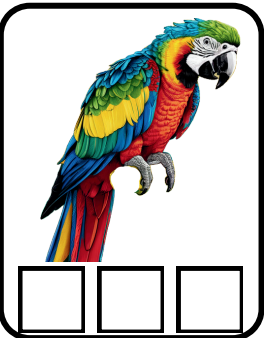

# “ n – N ” Sesini Okuyup–Yazalım

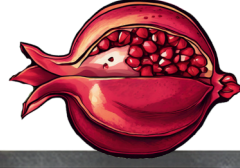
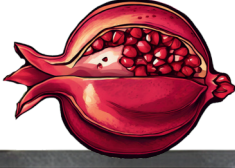

- “ n – N ” harflerini yazalım, yazdığımız harfi söyleyelim.

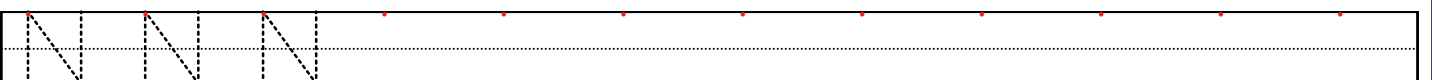
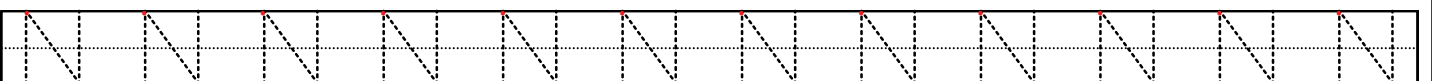
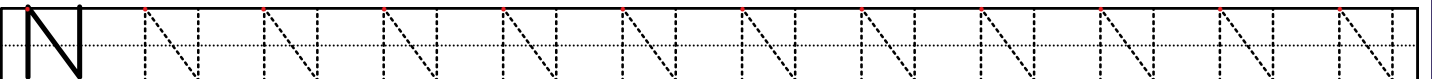
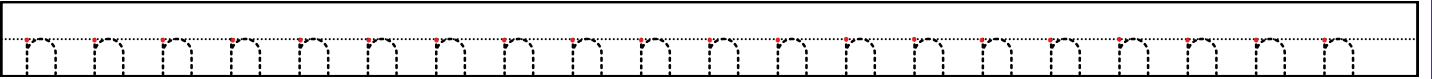
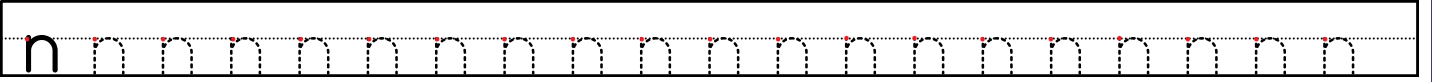

- Aşağıdaki görsellerin ne olduğunu söyle, "n" sesini bul, daire içine al.



n i n e



n a r



n o t a



n a n e



n a l



n o k t a

- " n " harflerini yazalım.

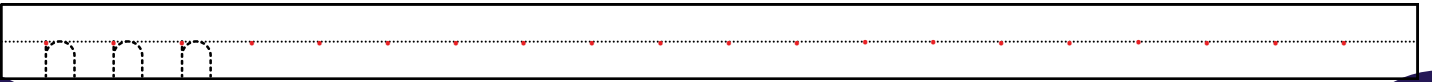
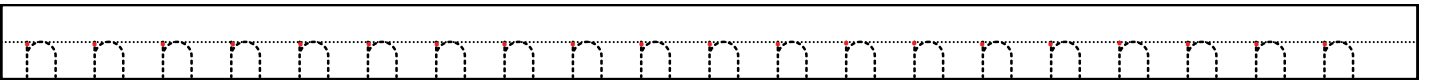

- Aşağıdaki görsellerin ne olduğunu söyle, "n" sesini bul, daire içine al.



eldiven



maymun



aslan



papağan



balon



tavşan

- "n" harflerini yazalım.

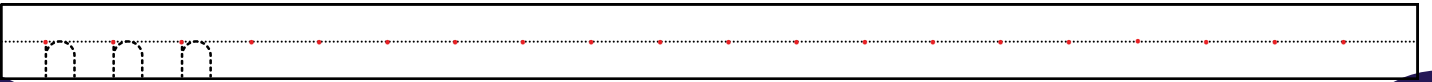
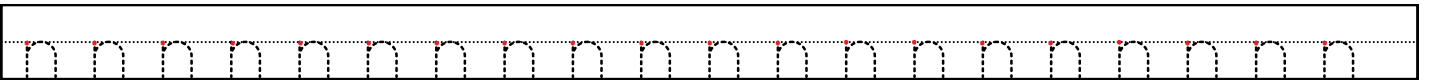

a n

an an an an an an an an



an an an an an an an an

an

an

an

- Çizgi ile "an" hecelerini takip ederek çocuęu evine ulařtıralım.

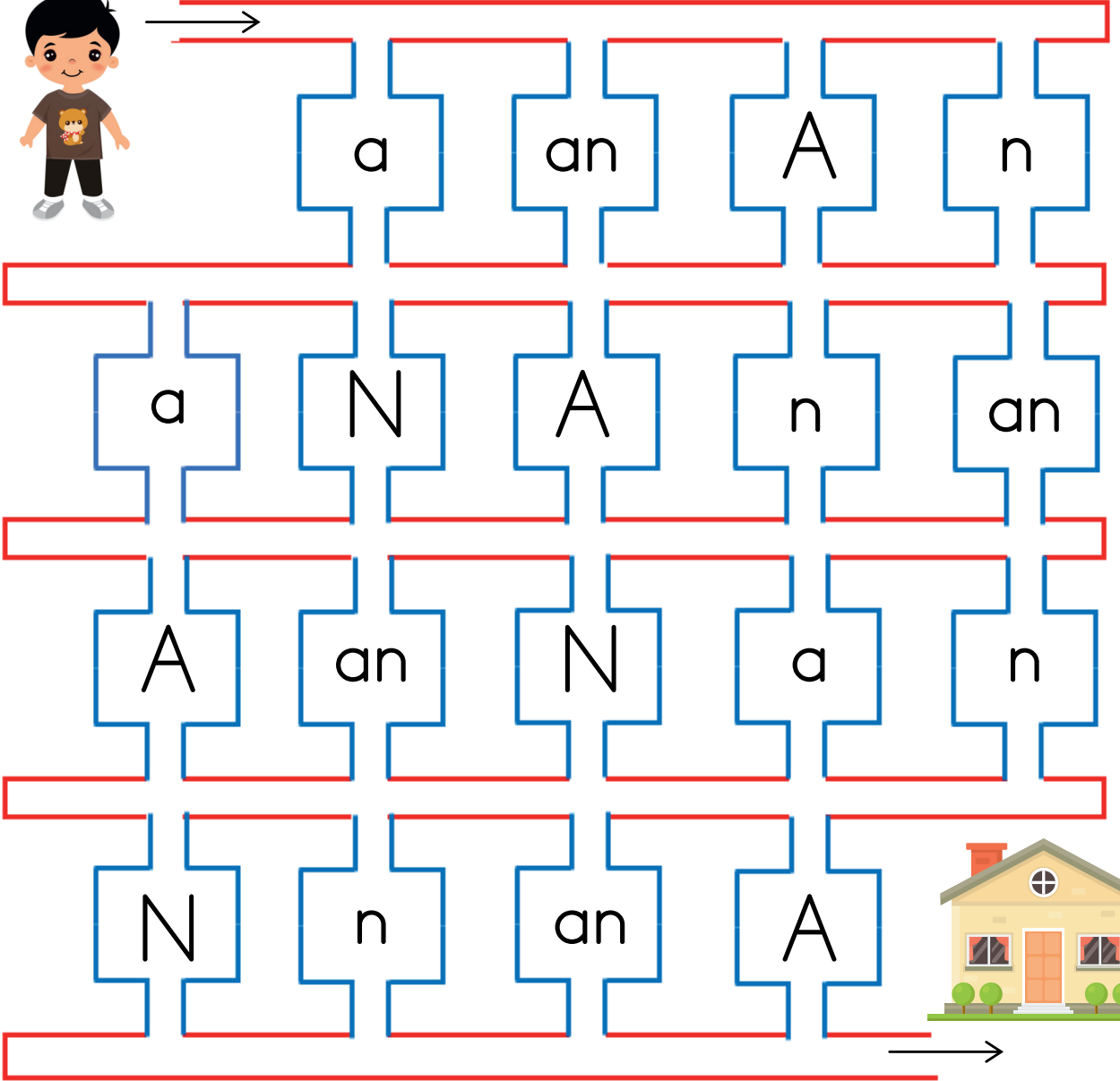

n a

na na na na na na na na



na na na na na na na na

na

na

na

- Çizgi ile "na" hecelerini takip ederek çocuęu evine ulařtıralım.

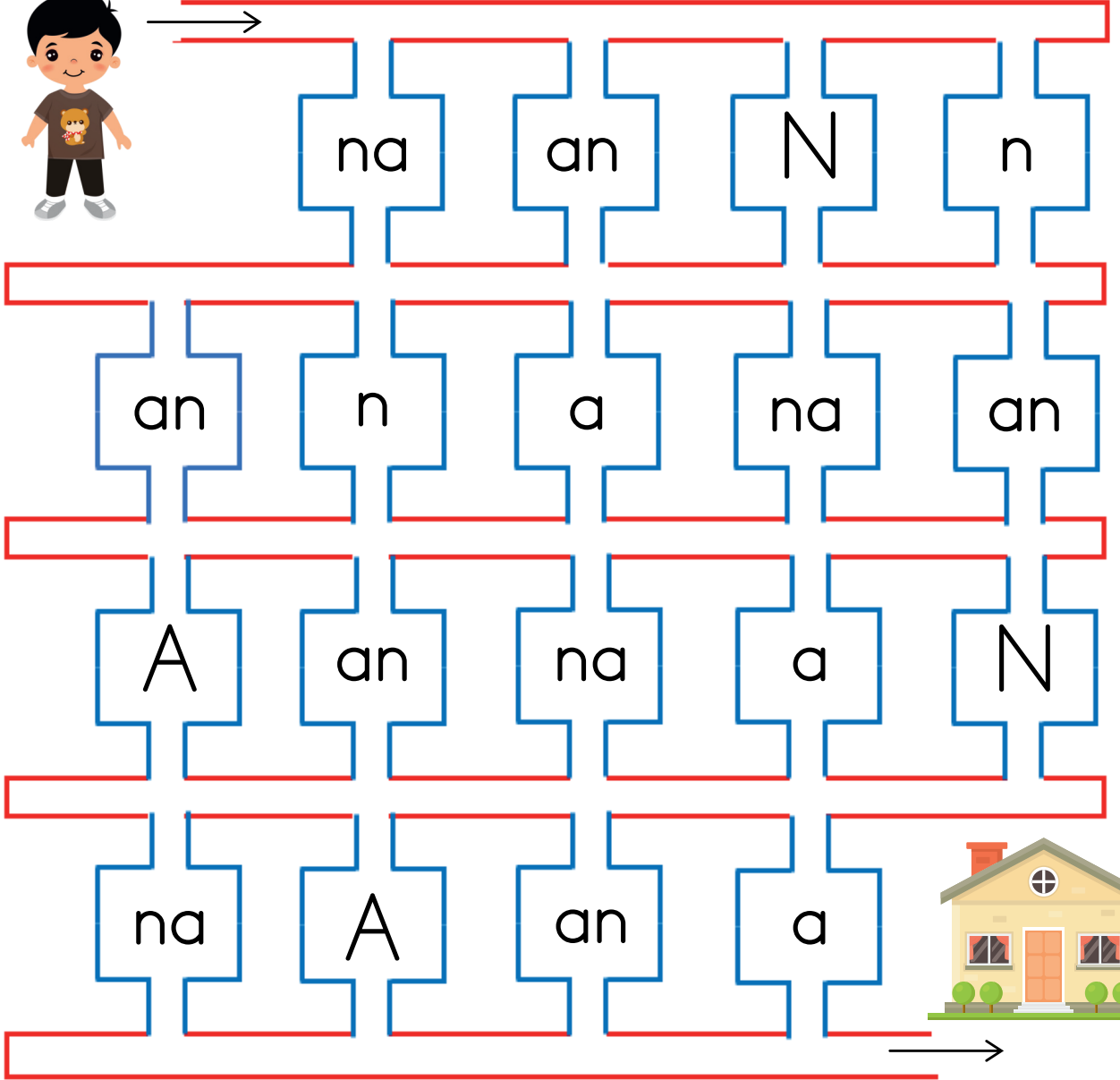

a na  
ana



ana ana ana ana

ana ana ana ana

ana

ana

- Çizgi ile "ana" kelimelerini takip ederek çocuğu evine ulaştıralım.

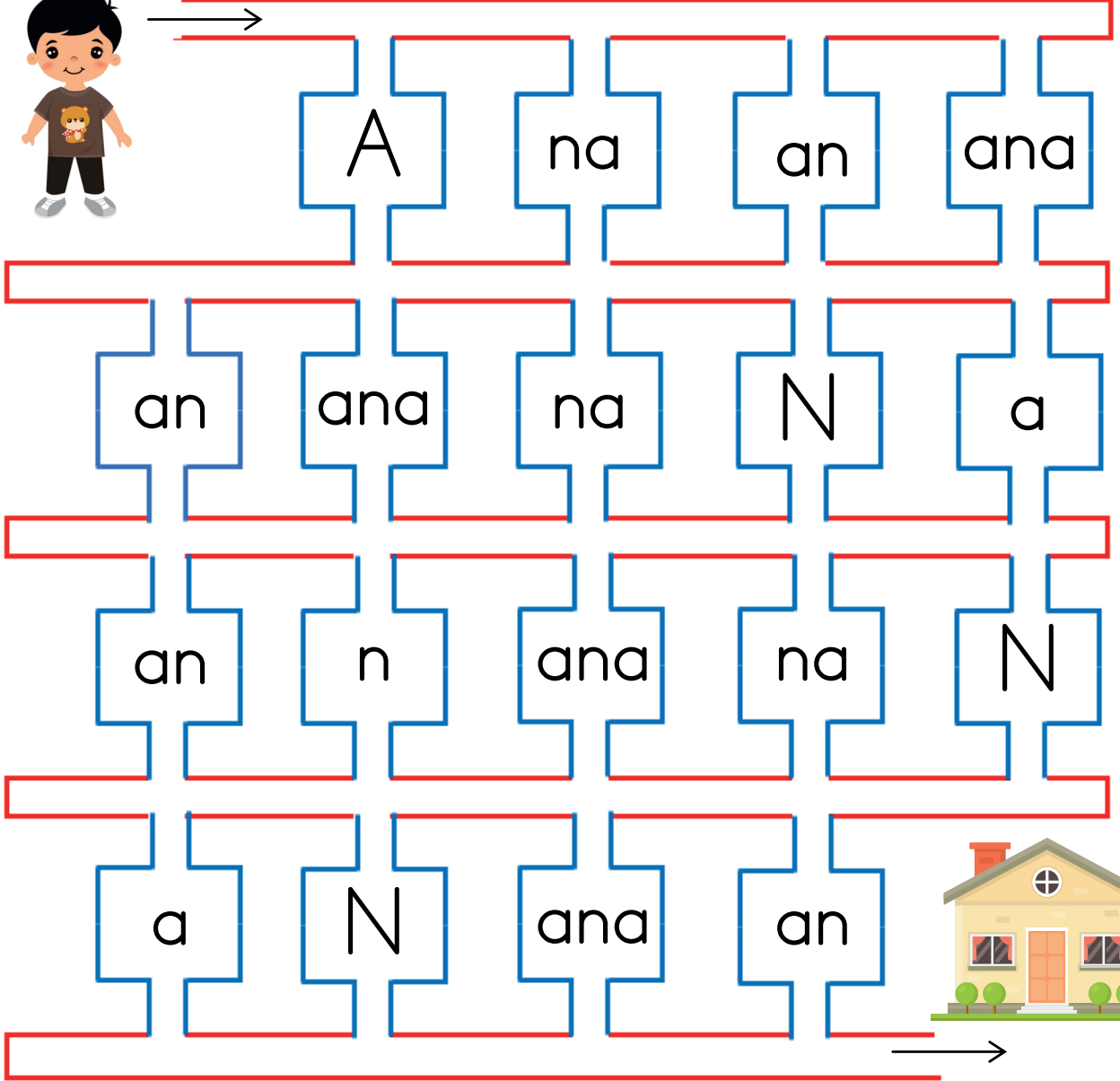

a n

an an an an an an an an



an an an an an an an an

an

an

n a

na na na na na na na na



na na na na na na na na

na

na

a na

ana ana ana ana



ana ana ana ana

ana

ana



an

na

ana

• Okuyalım, yazalım.

a a a

A A

n n n

N N

an

an

na

na

ana

ana

ana

ana



“e – E”  
Sesini  
Öğreniyorum

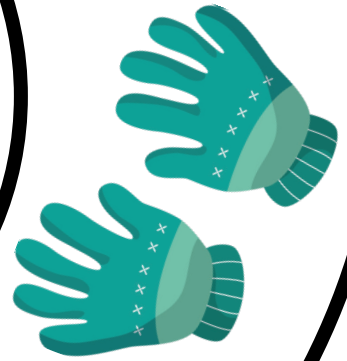

## “ e – E ” Sesini Ayırt Etme

- Adında “ e ” sesi olan varlıkların altındaki kutucukları boyayalım.

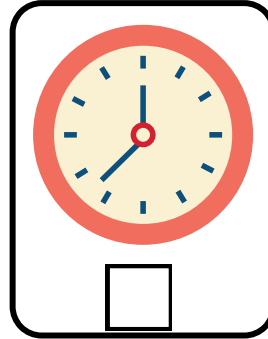
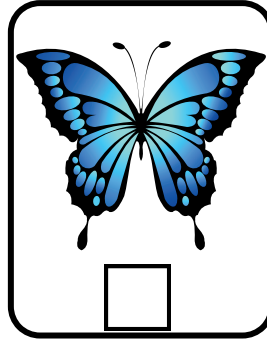
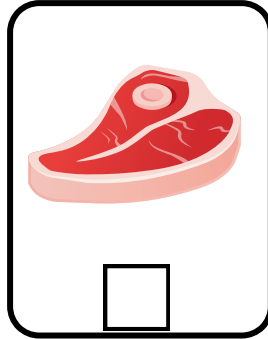
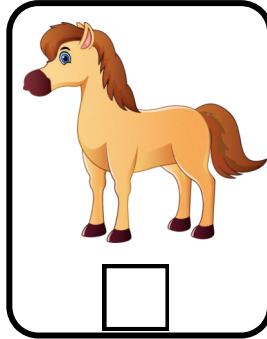
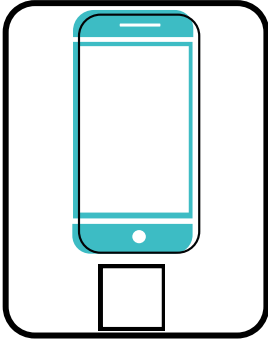
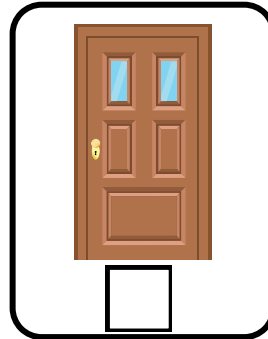
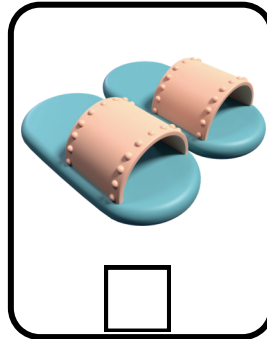
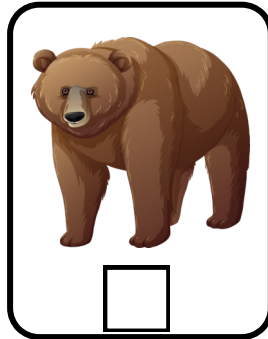
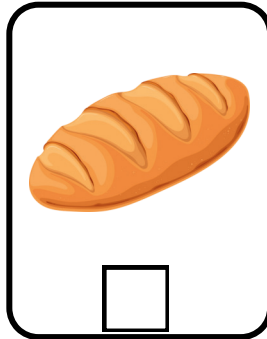
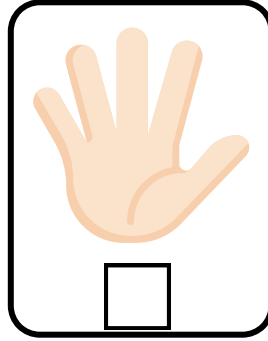
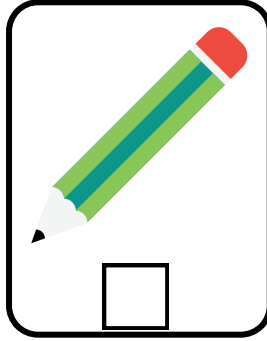
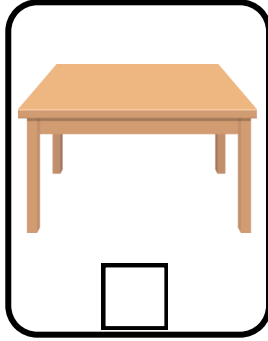
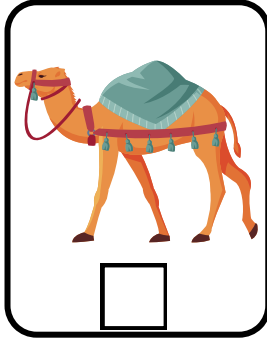
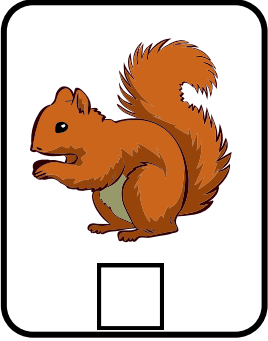

- Aşağıdaki varlıkların adında “ e ” sesi baştaysa 1. kutuyu, ortadaysa 2. kutuyu, sonda ise 3. kutuyu boyayalım.

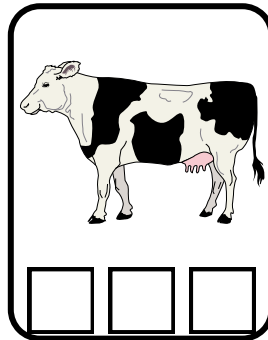
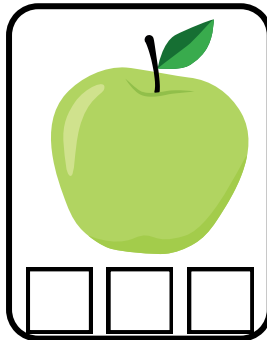
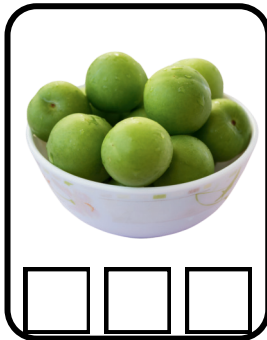
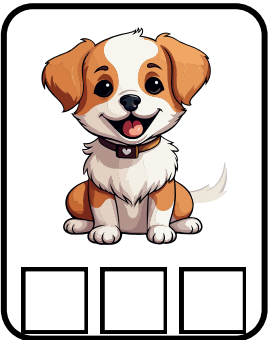

# “ e – E ” Sesini Okuyup–Yazalım

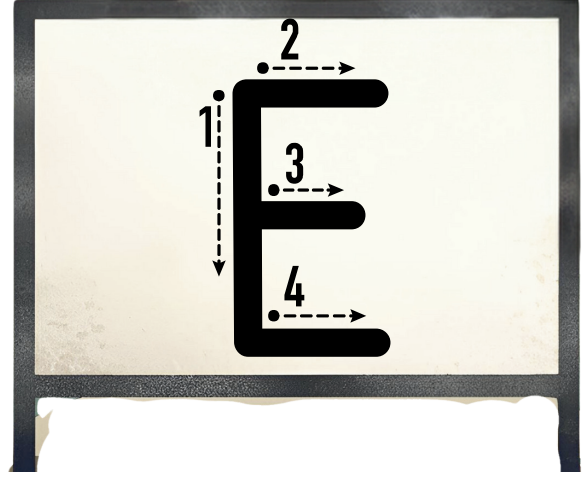

- “ e – E ” harflerini yazalım, yazdığımız harfi söyleyelim.

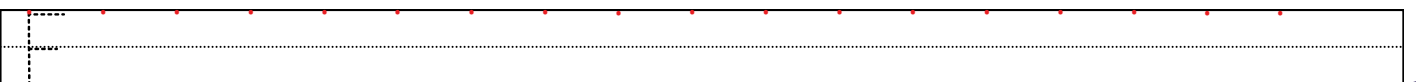
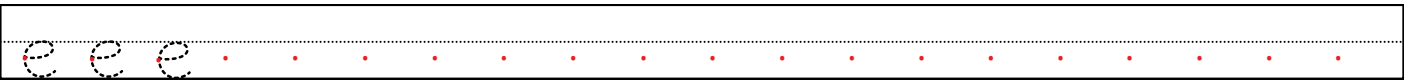
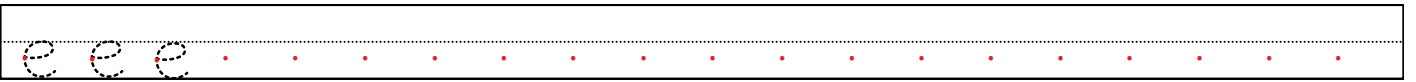
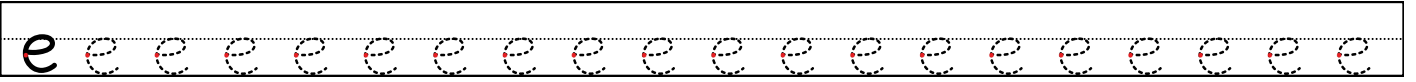
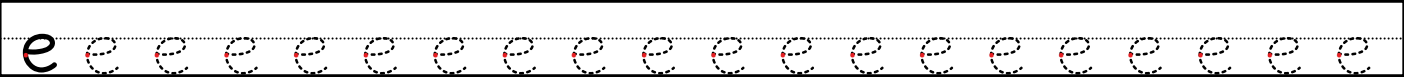





e n

en en en en en en en en



en en en en en en en en

en

en

en

- Çizgi ile "en" hecelerini takip ederek çocuğu evine ulařtıralım.

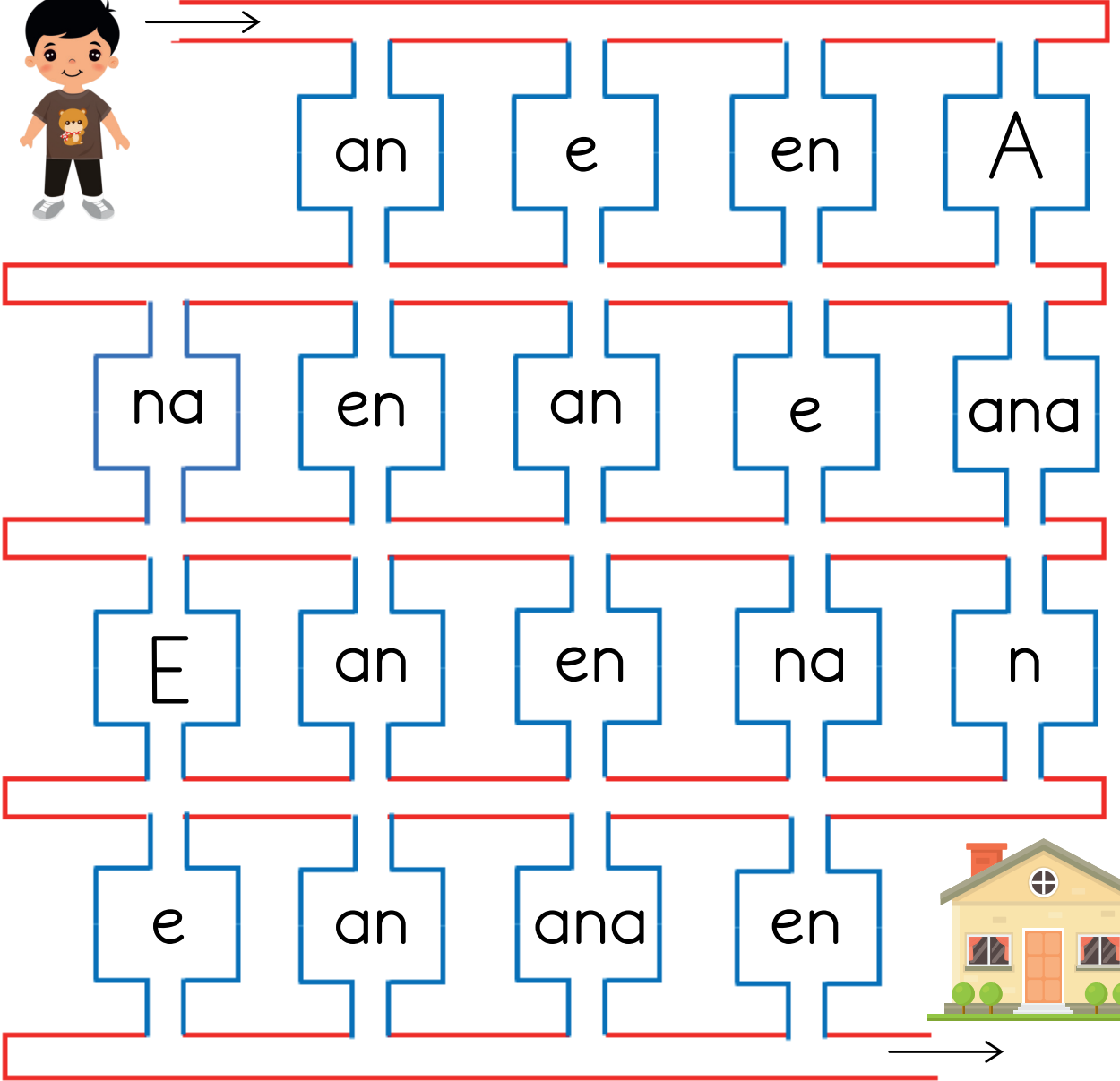

n e

ne ne ne ne ne ne ne ne



ne ne ne ne ne ne ne ne

ne

ne

ne

- Çizgi ile "ne" hecelerini takip ederek çocuęu evine ulařtıralım.

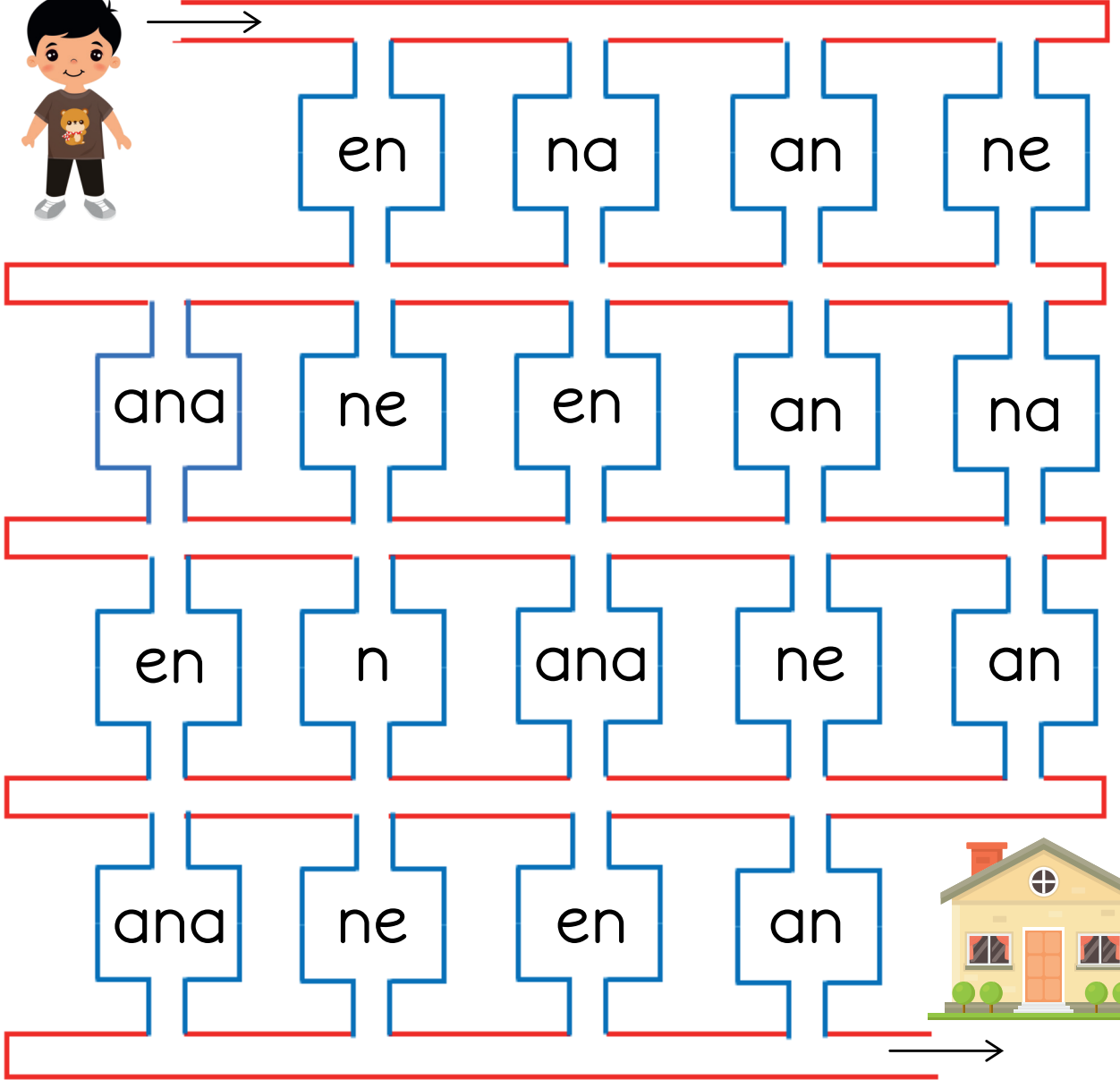

an ne



anne



anne anne anne

anne anne anne

anne

anne

- Çizgi ile "anne" kelimelerini takip ederek çocuğu evine ulaştıralım.

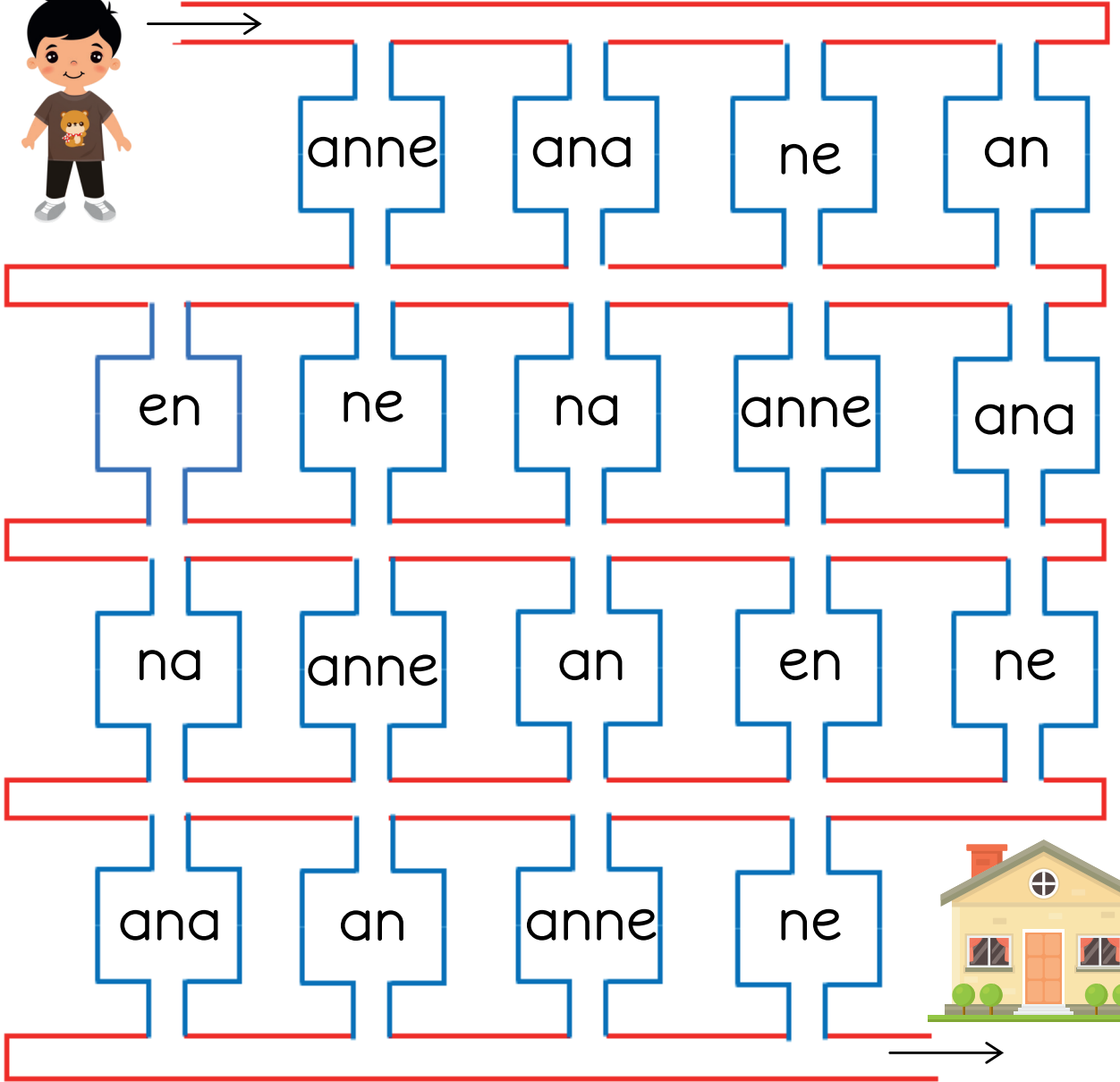

na ne



nane



nane nane nane

nane nane nane

nane

nane

- Çizgi ile "nane" kelimelerini takip ederek çocuğu evine ulařtıralım.

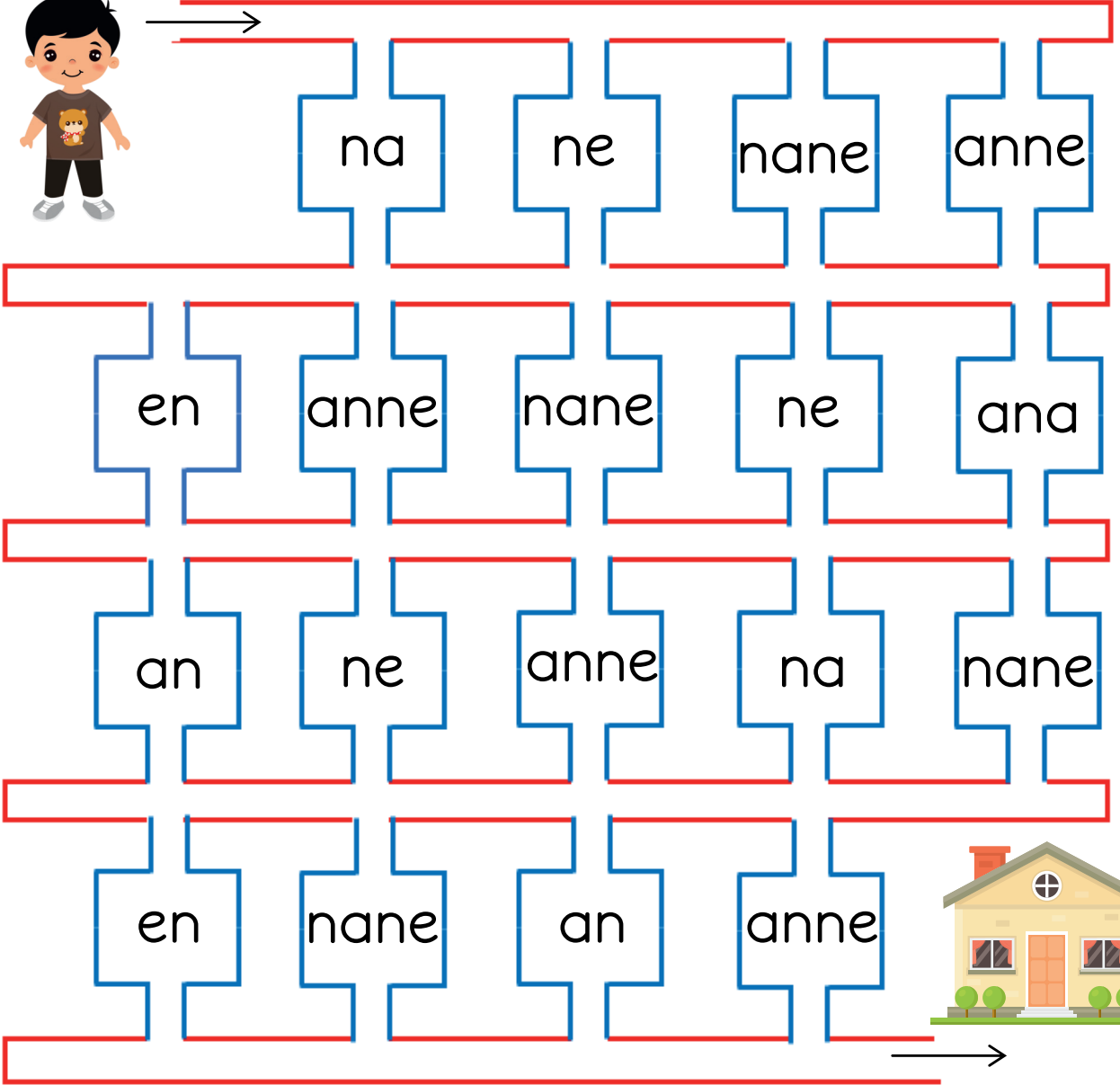

- Aşağıdaki hece ve kelimeleri okuyup, yazalım.

an

na

ana

en

ne

anne

anne

anne

nane

nane

nane

an na ana en ne anne nane

• Harf, hece, kelime diktesi yapılacak

--

--

--

--

--

--

--

--

--

--

--

--

--

--

--

--

--

--

--

--

--

--

--

--

--

--

--

--

--

--

--

--

--

--

--

--

--

--

--

--

--

--

--

--



“t – T”  
Sesini  
Öğreniyorum

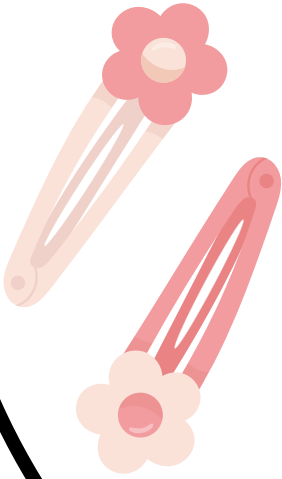

## “ t – T ” Sesini Ayırt Etme

- Adında “ t ” sesi olan varlıkların altındaki kutucukları boyayalım.

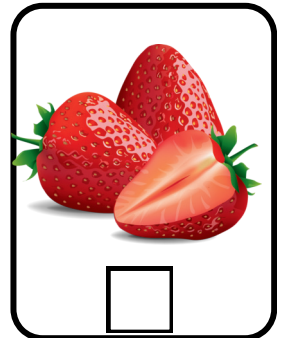
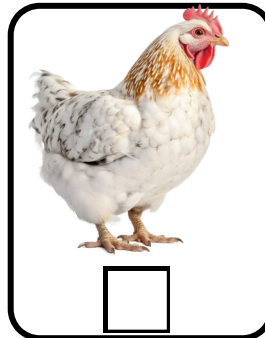
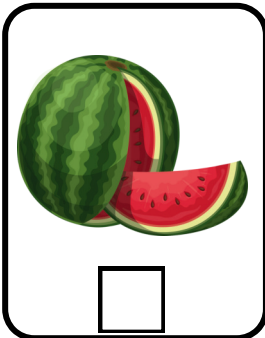
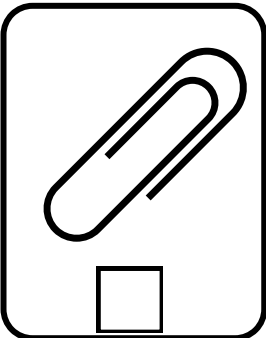
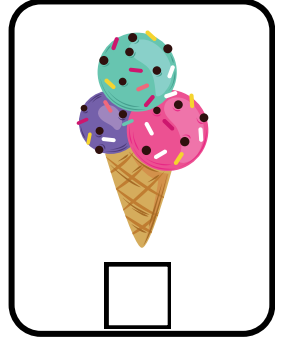
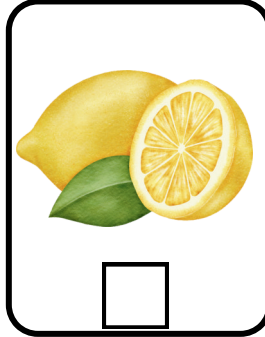
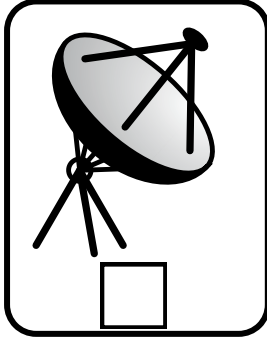
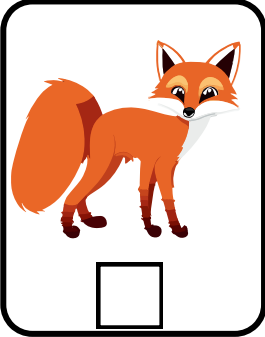
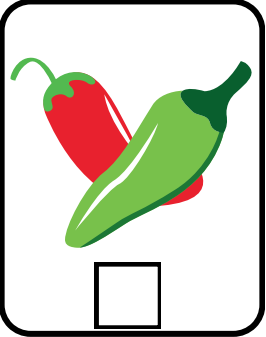
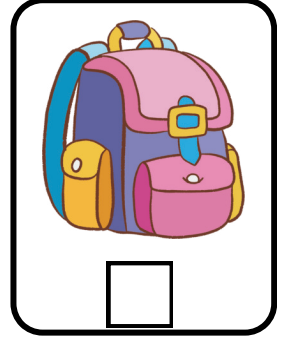
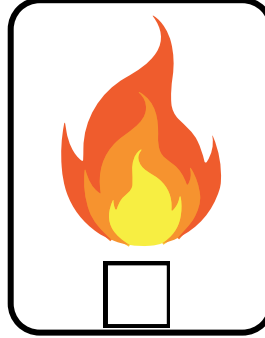
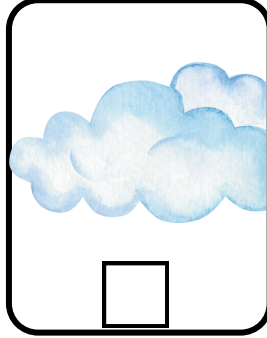
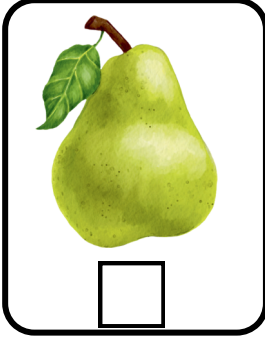
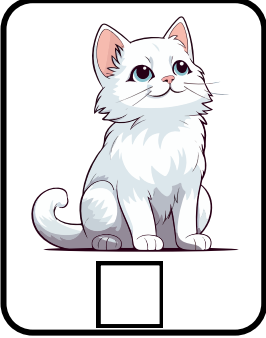

- Aşağıdaki varlıkların adında “ t ” sesi baştaysa 1. kutuyu, ortadaysa 2. kutuyu, sonda ise 3. kutuyu boyayalım.

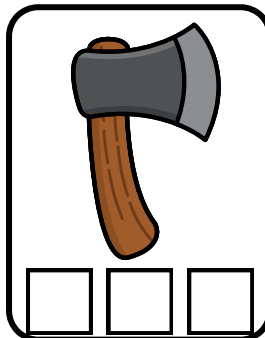
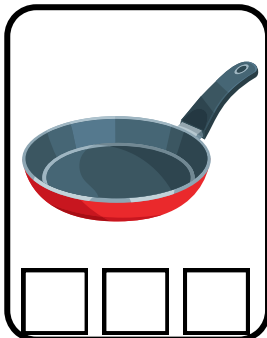
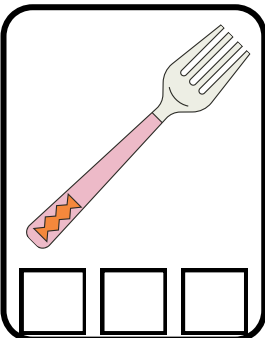
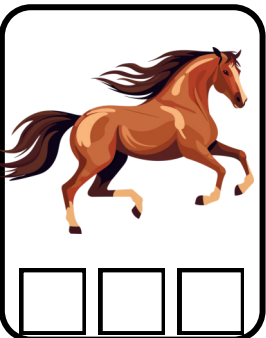

# “ t – T ” Sesini Okuyup–Yazalım

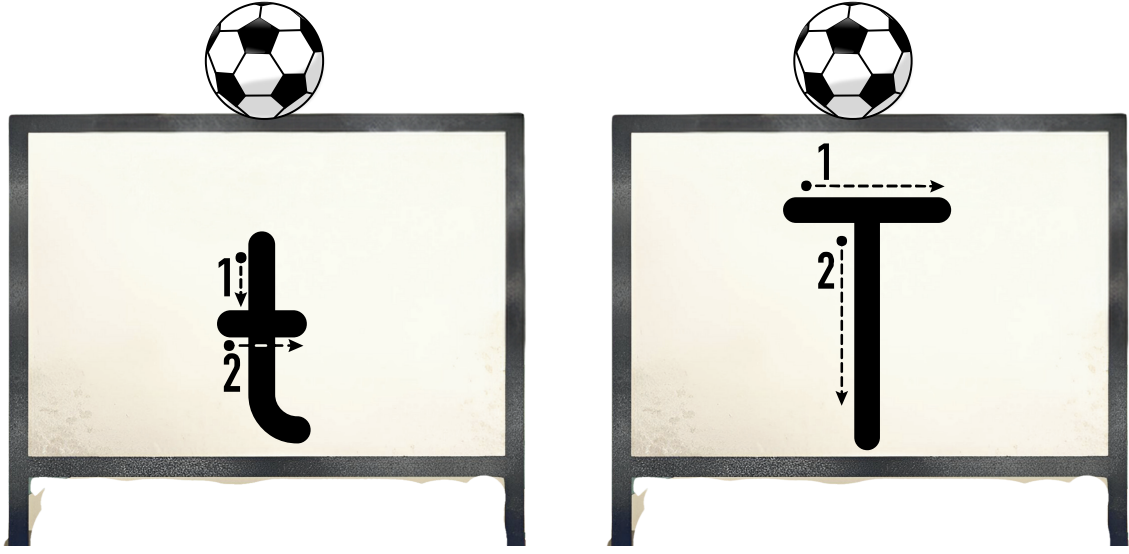

“ t – T ” harflerini yazalım, yazdığımız harfi söyleyelim.

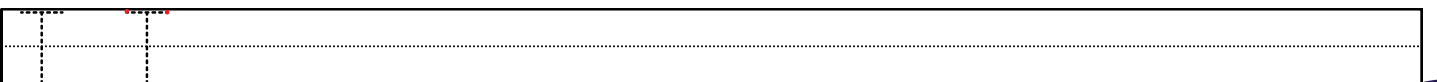
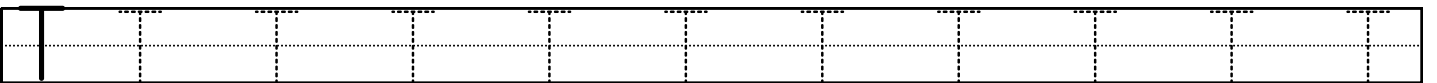
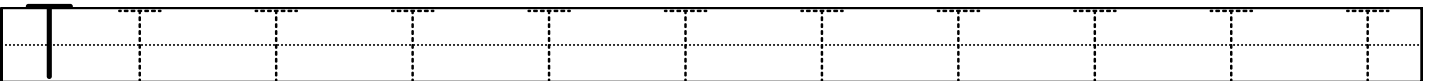
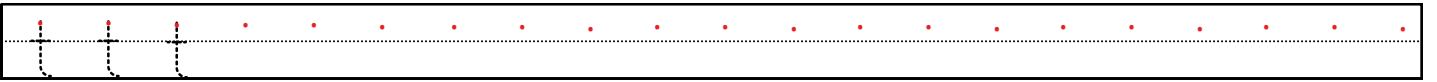
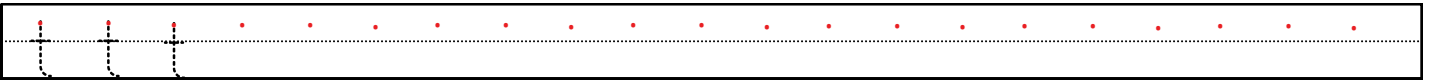

- Aşağıdaki görsellerin ne olduğunu söyle, "t" sesini bul, daire içine al.



t o p



t a r a k



t a v u k

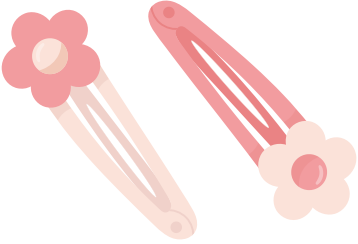

t o k a

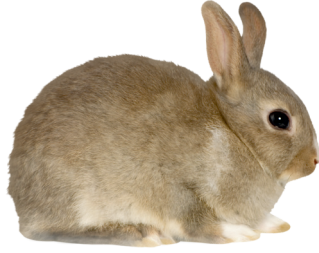

t a v ş a n



t e r l i k

- " t " harflerini yazalım.

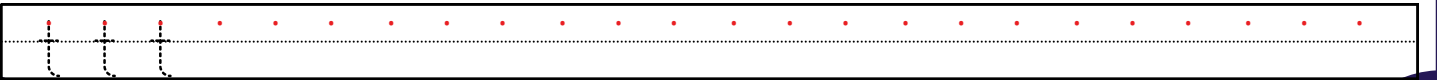
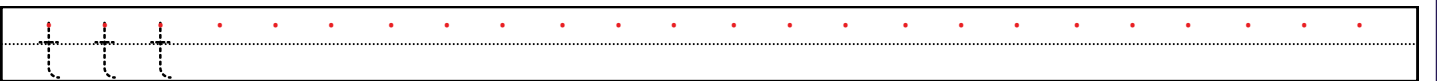
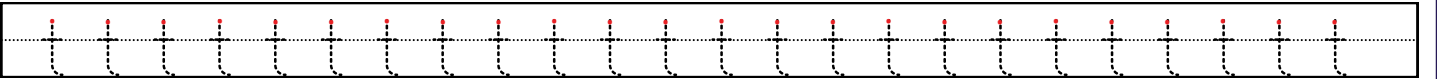

- Aşağıdaki görsellerin ne olduğunu söyle, "t" sesini bul, daire içine al.

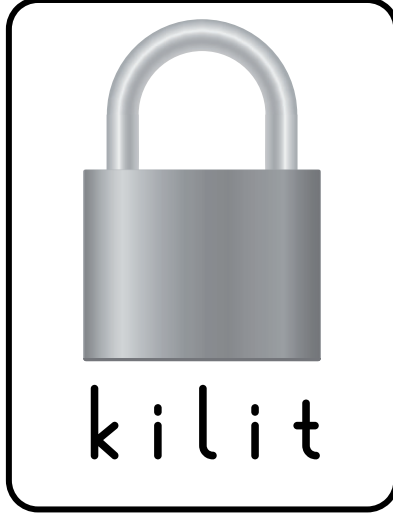
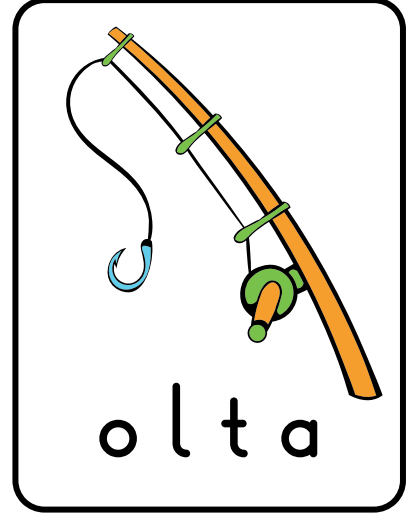

- " t " harflerini yazalım.

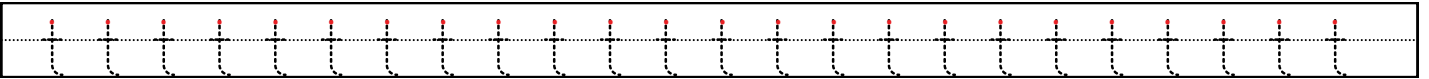

a t



at

at at at at at at at

at at at at at at at

at

at

- Çizgi ile "at" kelimelerini takip ederek çocuğu evine ulařtıralım.



na en an at

ne at na an ana

na anne at en an

ne at ana nane

e t



et

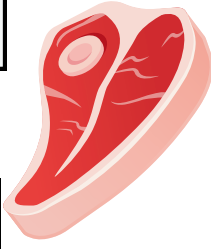

et et et et et et et

et et et et et et et

et

et

- Çizgi ile "et" kelimelerini takip ederek çocuğu evine ulařtıralım.



A maze with red walls and blue paths. The words 'et', 'at', 'tat', and 'an' are placed in the paths. The maze leads from the boy to a house at the end.



t a

ta ta ta ta ta ta ta ta ta



ta ta ta ta ta ta ta ta ta

ta

ta

ta ne

tane tane tane tane tane



tane tane tane tane tane

tane

tane

tane

a ta



Ata Ata Ata Ata



Ata Ata Ata Ata

ata

Ata



Ata

Ata

Ata

ta t



tat



tat tat tat tat tat

tat tat tat tat tat

tat

tat

- Okuyalım, yazalım

at

at

tane

tane

Ata

Ata

tat

tat

t e

te te te te te te te te te



te te te te te te te te te

te

te

te n

ten ten ten ten ten ten



ten ten ten ten ten ten

ten

ten

ten

an ten

anten anten anten



anten anten anten

anten

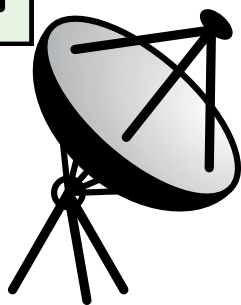

anten

anten

anten

- Okuyalım, yazalım

at

ta

tane

Ata

tat

et

te

ten

anten

- Aşağıdaki görsellerin adını yazalım.

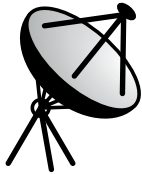



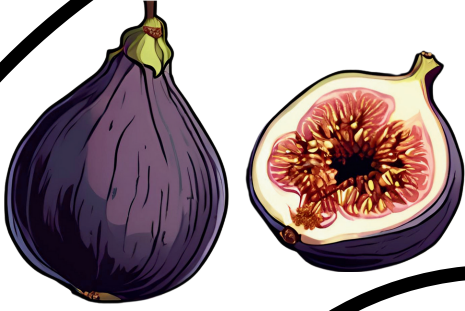

2

“i - i”  
Sesini  
Öğreniyorum

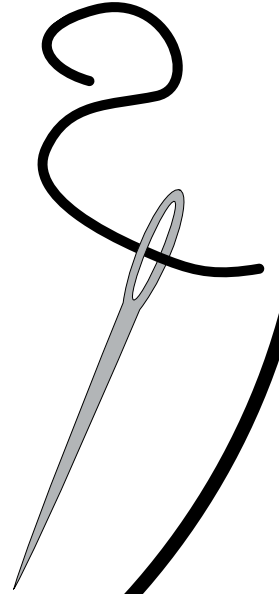

## “ i – İ ” Sesini Ayırt Etme

- Adında “ i ” sesi olan varlıkların altındaki kutucukları boyayalım.

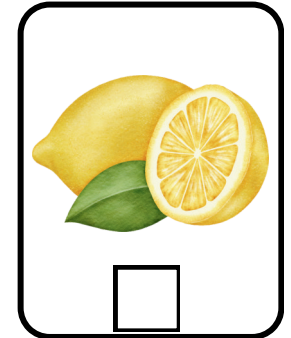
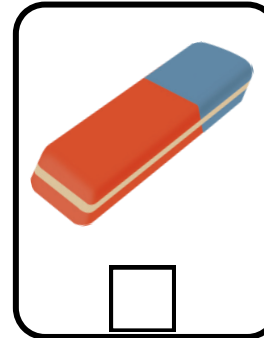
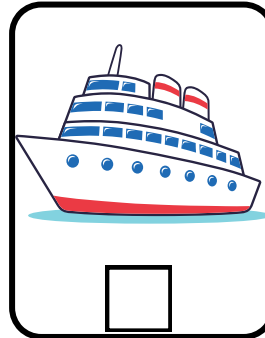
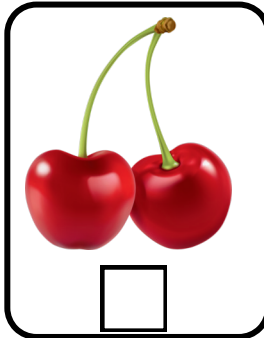
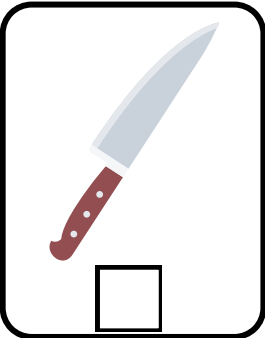
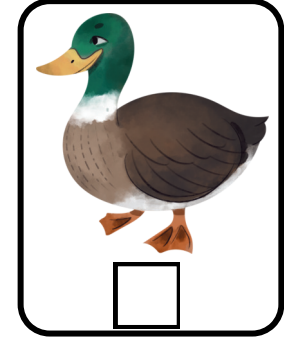
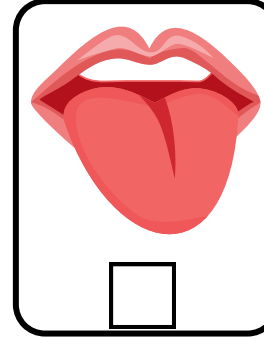
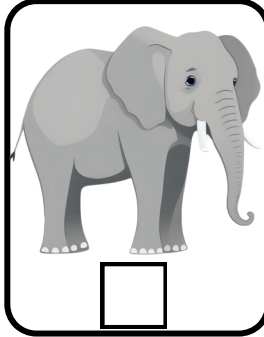
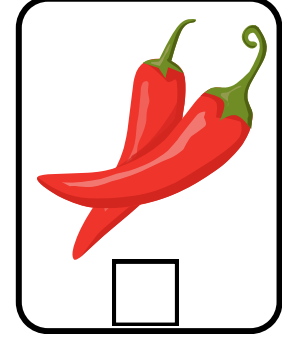
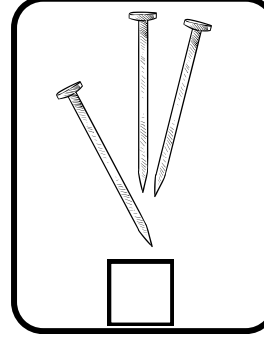
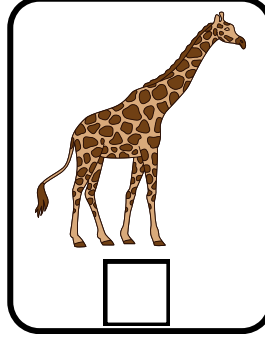
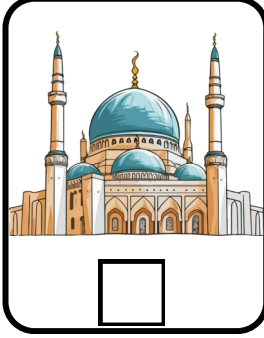
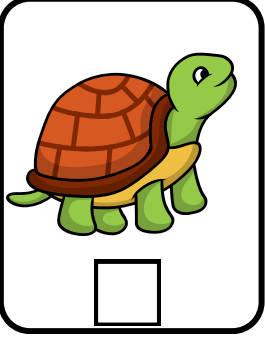

- Aşağıdaki varlıkların adında “ i ” sesi baştaysa 1. kutuyu, ortadaysa 2. kutuyu, sonda ise 3. kutuyu boyayalım.

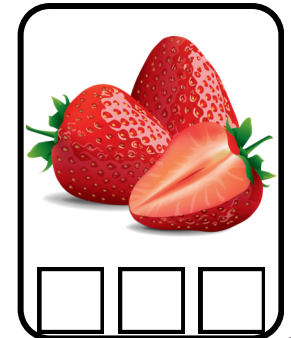
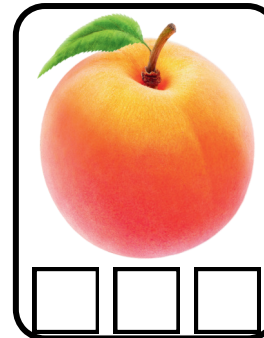
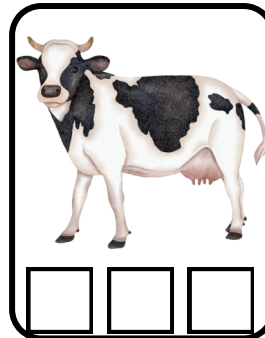
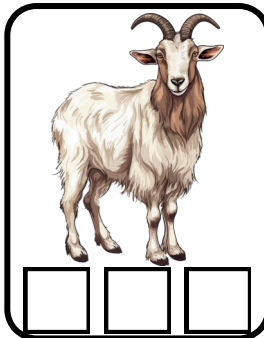
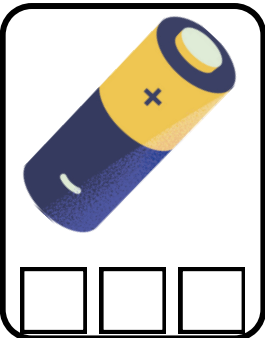

# “ i – İ ” Sesini Okuyup-Yazalım

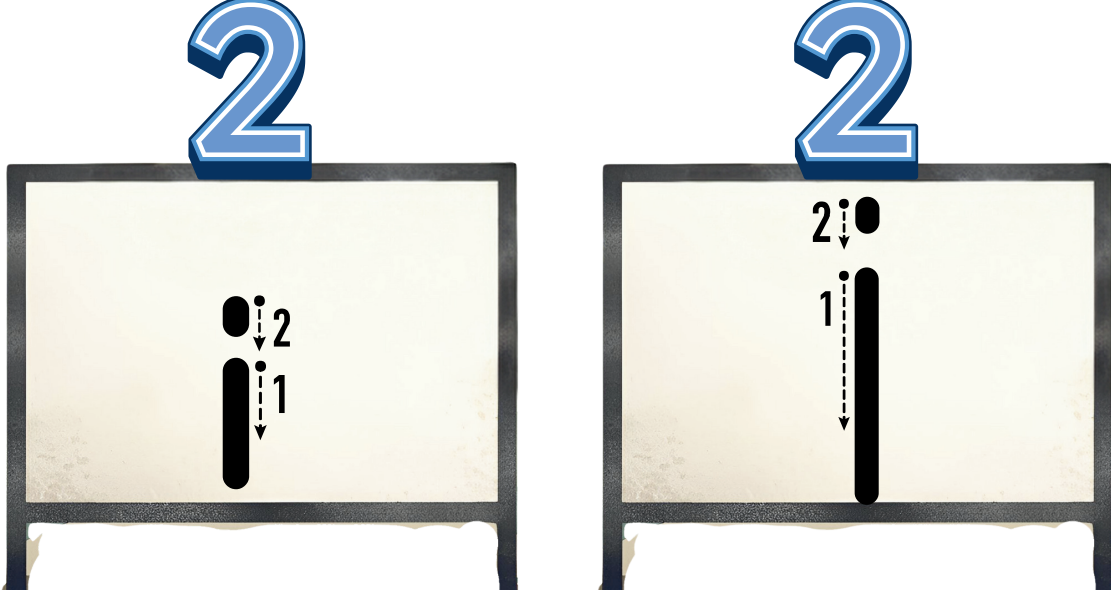

“ i – İ ” harflerini yazalım, yazdığımız harfi söyleyelim.

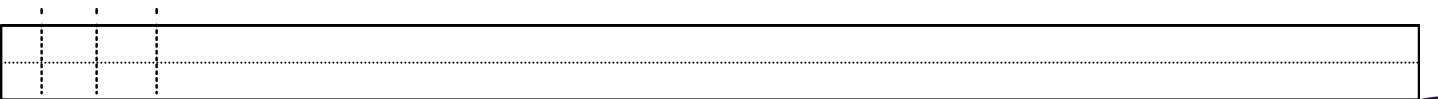
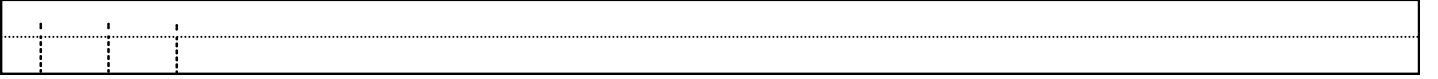
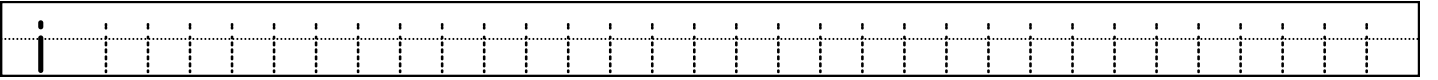

- Aşağıdaki görsellerin ne olduğunu söyle, "i" sesini bul, daire içine al.

2

iki

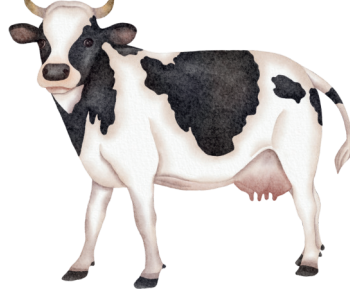

inek



incir

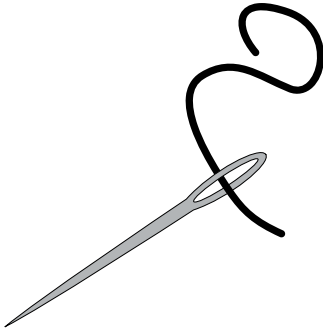

iğne



çilek



simit

- "i" harflerini yazalım.

Handwriting practice line with a dotted line for tracing.

Handwriting practice line with a dotted line for tracing.

Handwriting practice line with a dotted line for tracing.

- Aşağıdaki görsellerin ne olduğunu söyle, "i" sesini bul, daire içine al.

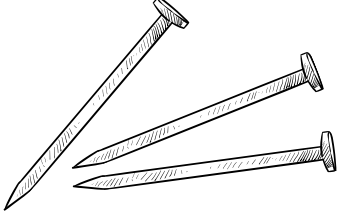

ç i v i



c a m i



ş e f t a l i



k e ç i

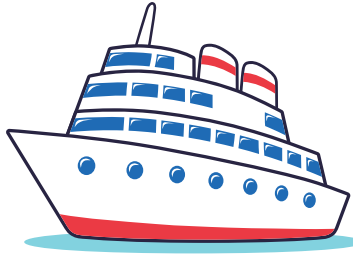

g e m i

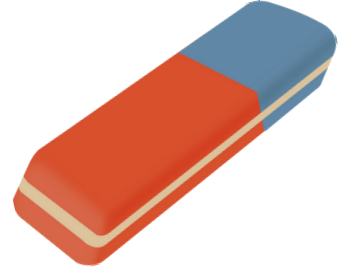

s i l g i

- " i " harflerini yazalım.

Handwriting practice line with a dotted line for the letter 'i'.

Handwriting practice line with a dotted line for the letter 'i'.

Handwriting practice line with a dotted line for the letter 'i'.

i n

in



in in in in in in in in in

in in in in in in in in in

in

in

- Çizgi ile "in" kelimelerini takip ederek çocuğu evine ulaştıralım.

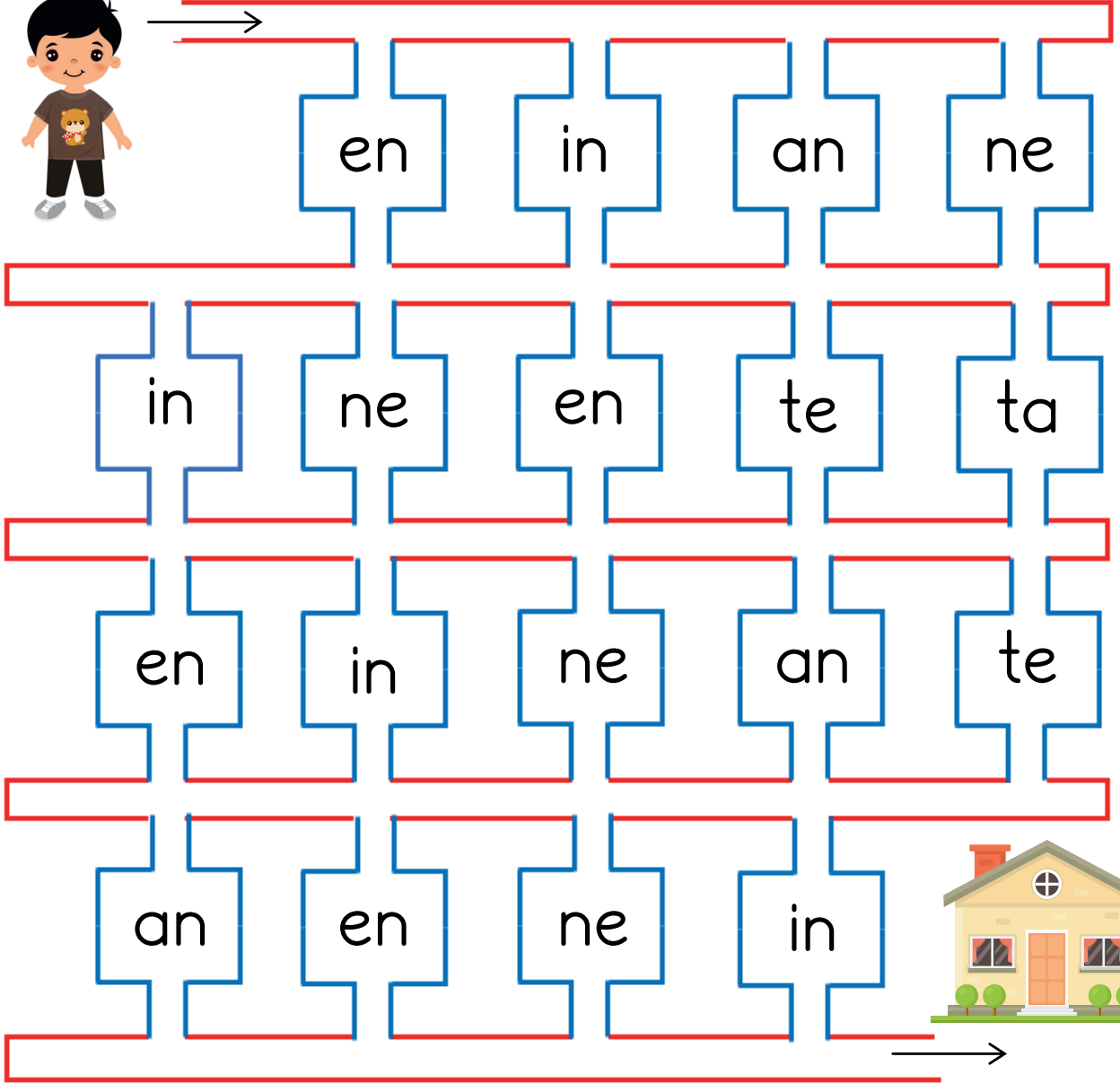

i t



it



it it it it it it it it it it

it it it it it it it it it it

it

it

- Çizgi ile "it" kelimelerini takip ederek çocuğu evine ulaştıralım.

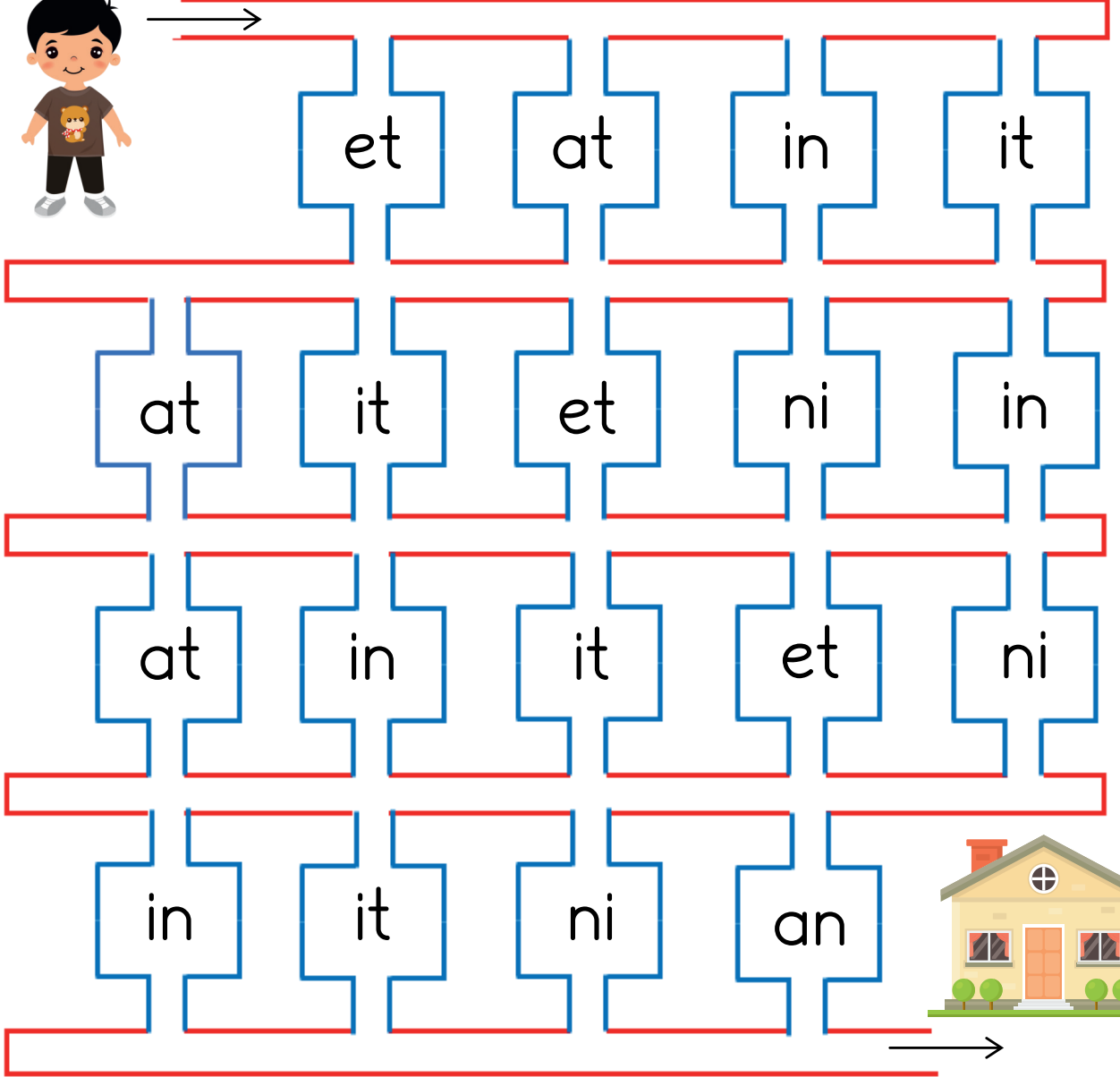

n

i

ni ni ni ni ni ni ni ni ni ni ni



ni ni ni ni ni ni ni ni ni ni ni

ni

ni

t

i

ti ti ti ti ti ti ti ti ti ti ti ti



ti ti ti ti ti ti ti ti ti ti ti ti

ti

ti

ni

ne

nine nine nine nine



nine nine nine nine

nine



nine

nine

nine

nine

ni n



nin



ninni ninni ninni ninni

ninni ninni ninni ninni

ninni ninni ninni ninni

ninni

ninni

ninni

nin ni



ninni

it ti



itti

itti itti itti itti itti itti

itti itti itti itti itti itti

itti

• Okuyalım, yazalım

in

nine

ninni

na t  
nat



i nat  
inat

inat inat inat inat inat inat inat inat

inat

- Okuyalım, yazalım

in

nine

ninni

inat

tat

anten

anne

• Harf, hece, kelime diktesi yapılacak

--

--

--

--

--

--

--

--

--

--

--

--

--

--

--

--

--

--

--

--

--

--

--

--

--

--

--

--

--

--

--

--

--

--

--

--

--

--

--

--

--

--

--

--



“l - L”  
Sesini  
Öğreniyorum

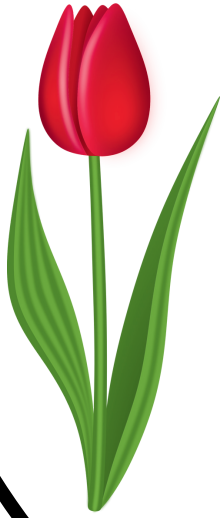
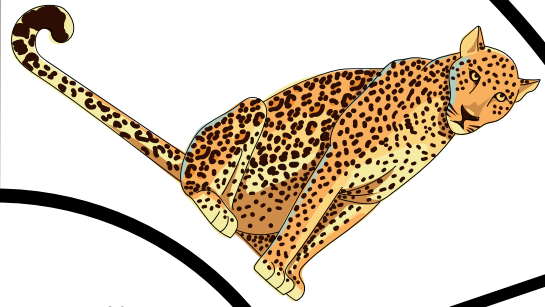

## “ l - L ” Sesini Ayırt Etme

- Adında “ l ” sesi olan varlıkların altındaki kutucukları boyyalım.

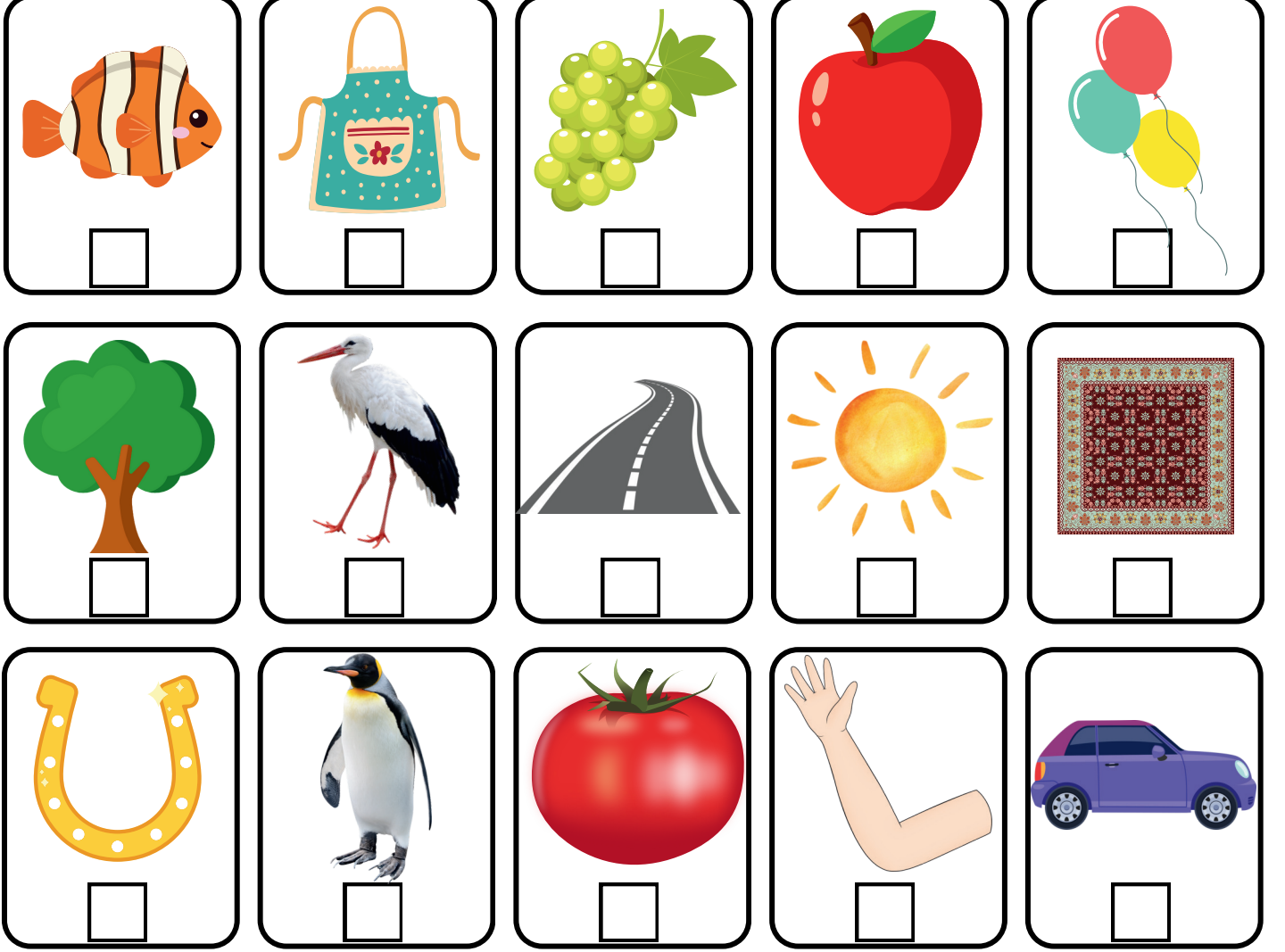

- Aşağıdaki varlıkların adında “ l ” sesi baştaysa 1. kutuyu, ortadaysa 2. kutuyu, sonda ise 3. kutuyu boyyalım.

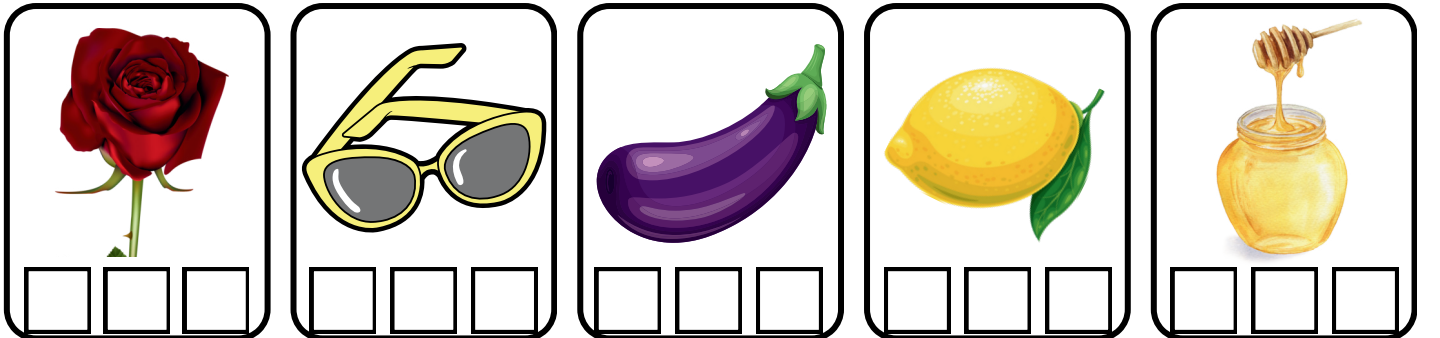

# “ l – L ” Sesini Okuyup–Yazalım



“ l – L ” harflerini yazalım, yazdığımız harfi söyleyelim.

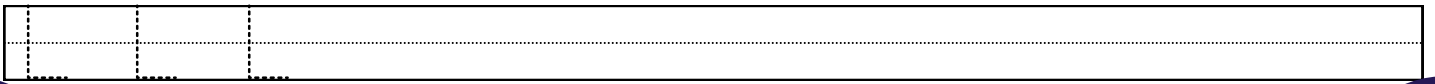
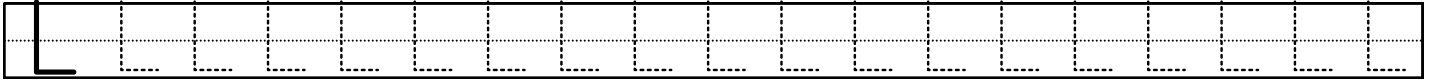
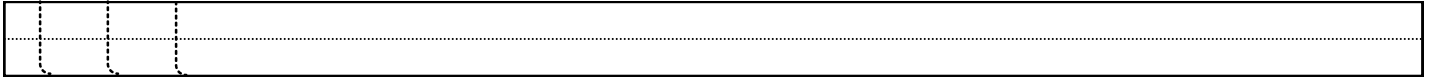
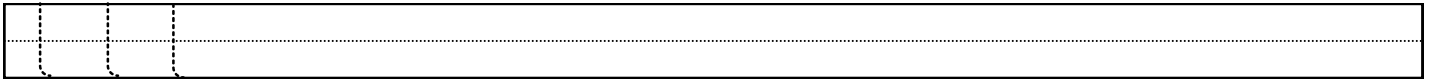
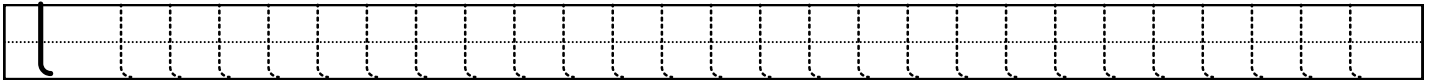

- Aşağıdaki görsellerin ne olduğunu söyle, "l" sesini bul, daire içine al.



l a l e



l e y l e k

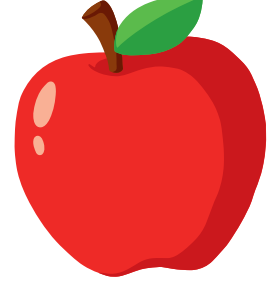

e l m a



b a l



ç i l e k



h a l ı

- " l " harflerini yazalım.

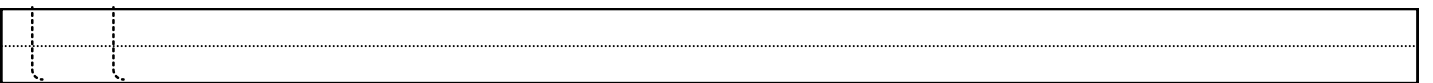
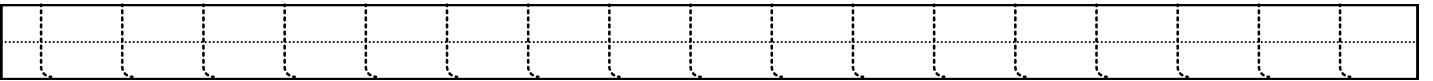

- Aşağıdaki görsellerin ne olduğunu söyle, "l" sesini bul, daire içine al.



l i m o n



g ü l



ş e f t a l i

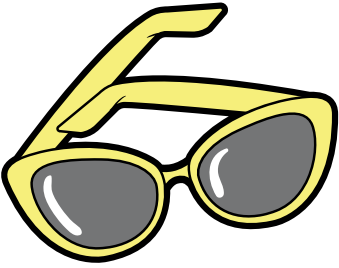

g ö z l ü k

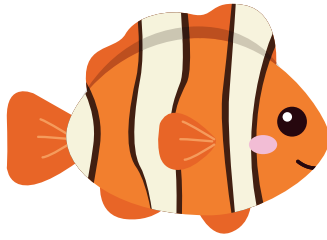

b a l ı k

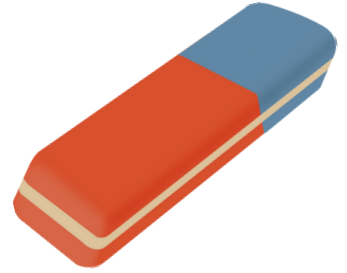

s i l g i

- " l " harflerini yazalım.

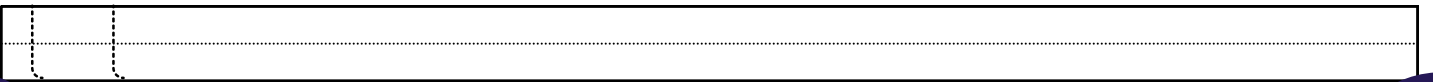
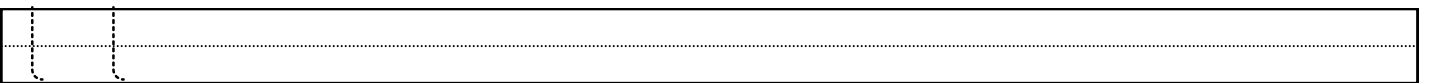
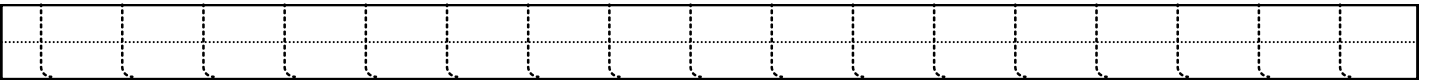

a l



al

al al al al al al al al

al al al al al al al al

al

al

e l



el



el el el el el el

el el el el el el

el

el

i l



il

il il il il il il il

il il il il il il il

il

il

l a

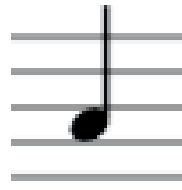

la

la la la la la la

la la la la la la

la

la

l e



le

le le le le le le

le le le le le le

le

le

l i



li

li li li li li li

li li li li li li

li

li

a li



Ali



Ali Ali Ali Ali Ali

Ali Ali Ali Ali Ali

Ali

Ali

el li



elli

50

elli elli elli elli elli

elli elli elli elli elli

elli

elli

et li



etli



etli etli etli etli etli

etli etli etli etli etli

etli

etli

la le



lale

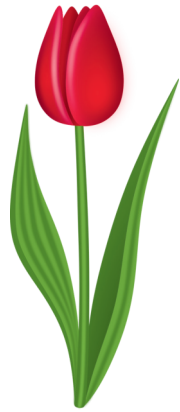

lale lale lale lale

lale lale lale lale

lale

lale

la le



Lale



Lale Lale Lale Lale

Lale Lale Lale Lale

Lale

Lale

e la



Ela



Ela Ela Ela Ela

Ela Ela Ela Ela

Ela

Ela

ni l



Nil



Nil Nil Nil Nil Nil

Nil Nil Nil Nil Nil

Nil

Nil

te l



tel



tel tel tel tel tel

tel tel tel tel tel

tel

tel

na l



nal



nal nal nal nal nal

nal nal nal nal nal

nal

nal

le t



let

let let let let let

let let let let let

let

let

a let



alet



alet alet alet alet

alet alet alet alet

alet

alet

at let



atlet



atlet atlet atlet atlet

atlet atlet atlet atlet

atlet

atlet

i le



ile

ile ile ile ile ile ile

ile ile ile ile ile ile

ile

ile

at la



atla



atla atla atla atla

atla atla atla atla

atla

atla

li la



lila



lila lila lila lila lila

lila lila lila lila lila

lila

lila

ti l



til

til til til til til til

til til til til til til

til

til

ta til



tatil



alet alet alet alet

alet alet alet alet

alet

alet

a i le



aile



aile aile aile aile

aile aile aile aile

aile

aile

• Okuyalım, yazalım.

el

al

Ali

elli

etli

lale

Lale

Ela

Nil

tel

nal

atlet

• Görsellerin isimlerini yazınız.



50

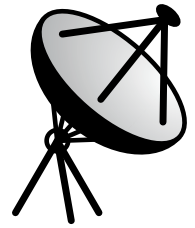



e le



ele

ele ele ele ele ele

ele ele ele ele ele

ele

el ele



el ele el ele el ele

el ele el ele el ele

el ele

el ele

el ele

na lan



Nalan



Nalan Nalan Nalan

Nalan Nalan Nalan

Nalan

Nalan

al t



alt



alt alt alt alt alt

alt alt alt alt alt

alt

an la



anla

anla anla anla anla

anla anla anla anla

anla anla anla anla

anla

anla

na il



Nail



Nail Nail Nail Nail

Nail Nail Nail Nail

Nail Nail Nail Nail

Nail

- Okuyalım, yazalım.

Nil lale al.

Nil lale al.

Ali atlet al.

Ali atlet al.

Ela ile Nalan el ele.

Ela ile Nalan el ele.

Anne ete nane at.

Anne ete nane at.

- Okuyalım, yazalım.

Nail elli nal al.

Nail elli nal al.

Ali ninene elli lale al.

Ali ninene elli lale al.

Nil eti tat.

Nil eti tat.

Nalan lila atlet al.

Nalan lila atlet al.

• Görsellerin isimlerini yazınız.



50

